



*Architectural & Decorative
Plaster Mouldings
Specialist*

HKH TM

Manufacturer, Supplier & Exporter.

INTRODUCTION



HOCK KENG HENG (HKH) Plaster Industrial is one of the largest manufacturers and exporters of Glass Fibre Reinforced Plaster/Gypsum (GRP/GRG)/architectural gypsum moulding/gypsum cornice and mouldings/plaster mouldings materials.

All our GRP/GRG mouldings are modeled, moulded and produced with high quality non-toxic and non-combustible plaster (gypsum) powder and glass fibre to produce fine quality, excellent and durable products.

Our GRP/GRG products comply with fire resistance test, Class "O" rating. They have also passed the BS 476 Part 4 : 1970 (84) - Non-Combustibility Test. BS 476 : Part 6 : 1989 - Fire Propagation Test, as well as the BS 476 : Part 7: 1997 - Surface Spread of Flame Test.

We sculpture elegant crown/cornice/frames/mouldings, center panel/ceiling roses/ceiling medallions, beading and curving corners, in addition to the decorative wall pieces/corbels, domes, fire base, wall niches, archs, roman round/square pillars/capitals, ceiling panels/relief cameo, plaster board and many other circular mouldings that add a classic and elegant dimension to wall and ceiling decorations.

We are seeking overseas buyers and distributors to represent our products in their respective countries. At present, we are exporting to 26 countries and our worldwide distributor network is rapidly growing. We offer very competitive prices to our dealers to match our excellent, fine quality products that are affordable for everyone.

HKH products can be touched up or painted with any type of paint. Specially made for decorative interior, non-structural use, our GRP/GRG products are suitable for use in new construction, residential and commercial premises, in line with decoration, renovation and restoration purposes.

Equipped with the most advanced technology, our manufacturing facility spans 60,000 m². With a large team of dedicated and skillful craftsmen, we are able to supply to the needs of projects of every size. We also welcome orders for custom-made designs and assure on-time delivery, every time. As an experienced manufacturer with a strong network of distributors and retailers worldwide, we are always upgrading our skills in GRP/GRG fabrication to cater to the ever-changing needs of our customers.

© Hock Keng Heng Plaster Industrial Sdn. Bhd.

ALL RIGHTS RESERVED, 2008

No part of this publication may be reproduced or transmitted in any form or by any means, electronic or mechanical, including photocopying, or by any information storage and retrieval system or otherwise, without permission in writing from the Copyright owner.

ENVIRONMENT-FRIENDLY PRODUCTS

*G*ypsum (plaster) is a natural mineral-based product. It is non-combustible, asbestos-free, and is free from harmful agents.

Gypsum / Plaster is easy to use – just mix with water and it is ready for use in fashioning designs to enhance walls and ceilings.

Its natural-based characteristics makes Gypsum / Plaster highly compatible with the modern environment as it works in harmony with nature and does not affect the ecological balance.



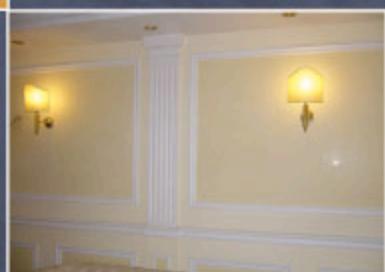
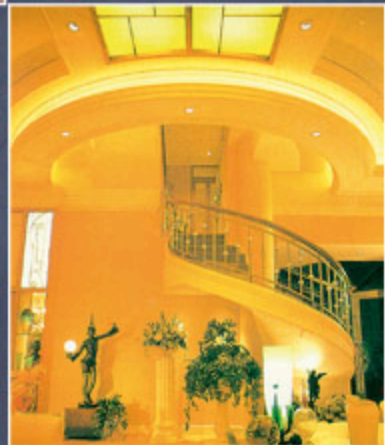

INDEX

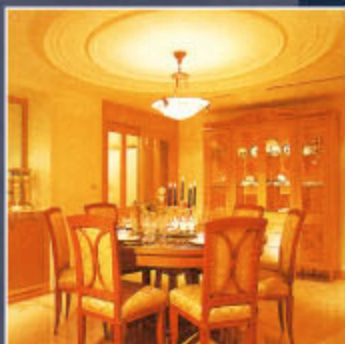

- 2 - 3 | Index
- 4 - 31 | Cornices / Elegant Frames
- 32 - 47 | Cornices Corners
- 48 - 59 | Center Panel / Ceiling Roses / Ceiling Medallions
- 60 - 69 | Frames / Beading / Curving Corners
- 70 - 79 | Decorative Wall Pieces / Corbels / Uplighters / Curving Corner / Fire Surround Et Niches
- 80 - 83 | Lighting Holder / Corners
- 84 - 89 | Ceiling Et Wall Panels / Relief / Cameo Et Board
- 90 - 97 | Circular Mouldings / L-Panel / Archs / Access Panel
- 98 - 103 | Roman Round / Square Pillars
- 104 - 109 | Domes



GORGEOUS CORNICICES FOR A MORE ELEGANT

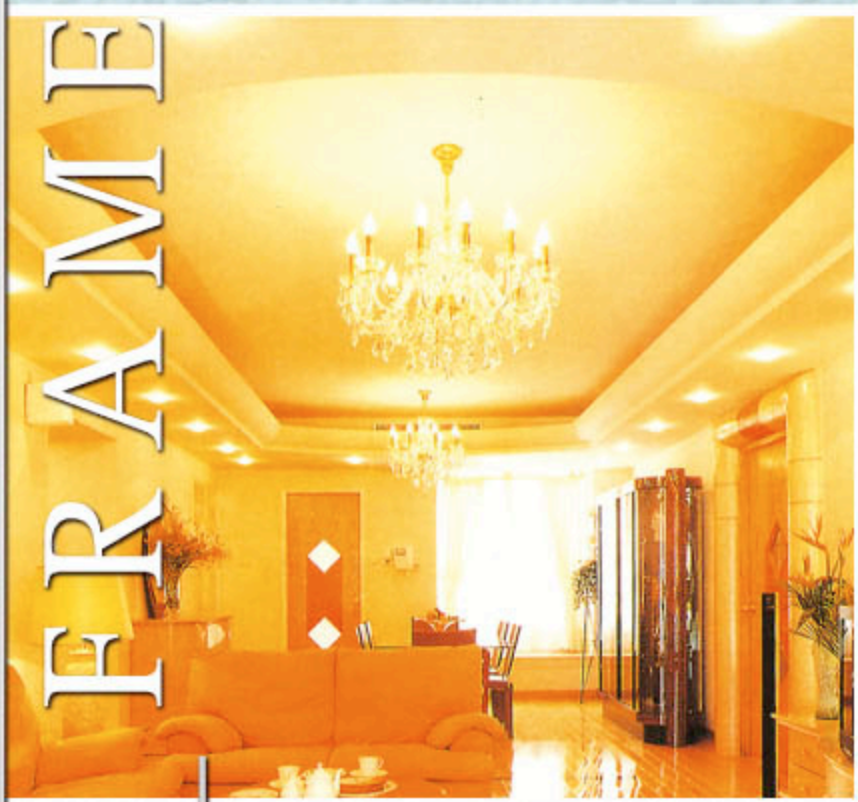

A perfect blend of tradition and technology. Classic elegance and old world charm reflected in a large array of distinctive motifs are an inspiration for designers, architects, craftsmen and homeowners. With exquisitely detailed mouldings, whether the décor theme is elegantly contemporary or traditional in style, HKH cornices live up to the grandest expectations.



CORNICES



Website: www.hkhplaster.com

Website: www.hkhplaster.com

HKH C100



HKH C104



HKH C101



HKH C114



HKH C102



HKH C119



HKH C103



HKH C120 (254)



UNIT = mm : inches

CORNICES



Add some Classical Designs
on your ceiling

Website: www.hkhplaster.com

HKH C143



Website: www.hkhplaster.com

HKH C147



HKH C121 (258)



Website: www.hkhplaster.com

HKH C149



HKH C122 (259)



HKH C154



HKH C123 (260)

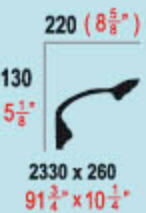
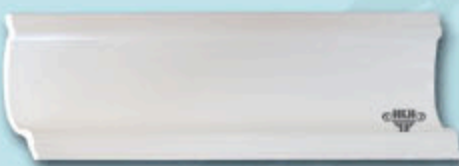

HKH C160



HKH C124 (261)

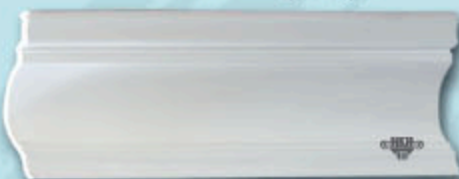

HKH C164



Product designs are copyright reserved.

UNIT = mm : Inches

CORNICES

HKH C167

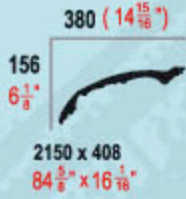

Website: www.hkhplaster.com

HKH C200



HKH C201



HKH C168



HKH C202

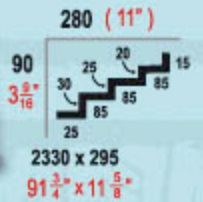

HKH C174



Website: www.hkhplaster.com

HKH C203



HKH C191



HKH C204



HKH C192



Website: www.hkhplaster.com

HKH C193

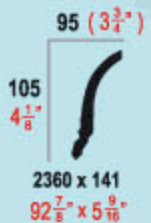

Product designs are copyright reserved.

UNIT = mm : inches

CORNICES

HKH C205 (JC299)

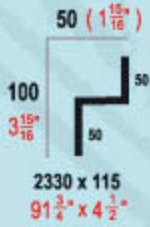

HKH C222



HKH C206



HKH C223



HKH C207 (WP 31)



HKH C232



HKH C211



HKH C233



HKN C213



HKN C234



HKH C235



Product designs are copyright reserved.

Website: www.hkhplaster.com

Website: www.hkhplaster.com

Website: www.hkhplaster.com

UNIT = mm : inches

CORNICES



Close-up of sample - Cornice joint installation.

HKH C266



HKH C267



HKH C236



HKH C273



HKH C241



HKH C274



HKH C253

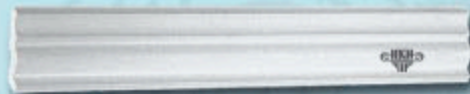

**HKH C277
HKH C278**



**HKH C255
HKH C256
HKH C257**



HKH C288



UNIT = mm : inches

CORNICES



HKH C316



60 (2 $\frac{3}{8}$ ")
 60
 2 $\frac{3}{8}$ "
 2330 x 85
 91 $\frac{3}{4}$ " x 3 $\frac{5}{16}$ "

HKH C318



95 (3 $\frac{3}{4}$ ")
 110
 4 $\frac{5}{16}$ "
 2300 x 145
 90 $\frac{9}{16}$ " x 5 $\frac{11}{16}$ "

HKH C301



115 (4 $\frac{1}{2}$ ")
 150
 5 $\frac{7}{8}$ "
 2360 x 189
 92 $\frac{7}{8}$ " x 7 $\frac{7}{16}$ "

HKH C319



140 (5 $\frac{1}{2}$ ")
 140
 5 $\frac{1}{2}$ "
 2370 x 198
 93 $\frac{5}{16}$ " x 7 $\frac{3}{4}$ "

HKH C310



120 (4 $\frac{3}{4}$ ")
 100
 3 $\frac{15}{16}$ "
 2440 x 156
 96 $\frac{1}{16}$ " x 6 $\frac{1}{8}$ "

HKH C320



100 (3 $\frac{15}{16}$ ")
 135
 5 $\frac{9}{16}$ "
 2440 x 168
 96 $\frac{1}{16}$ " x 6 $\frac{9}{16}$ "

HKH C311



118 (4 $\frac{5}{8}$ ")
 100
 3 $\frac{15}{16}$ "
 2360 x 154
 92 $\frac{7}{8}$ " x 6 $\frac{1}{16}$ "

HKH C313
HKH C314
HKH C315



135 (5 $\frac{5}{16}$ ")
 95 (3 $\frac{3}{4}$ ")
 75 (2 $\frac{15}{16}$ ")
 145 (5 $\frac{11}{16}$ ")
 105 (4 $\frac{1}{8}$ ")
 75 (2 $\frac{15}{16}$ ")
 2330 x 198 (91 $\frac{3}{4}$ " x 7 $\frac{3}{4}$ ")
 2330 x 142 (91 $\frac{3}{4}$ " x 5 $\frac{9}{16}$ ")
 2440 x 106 (96 $\frac{1}{16}$ " x 4 $\frac{3}{16}$ ")

HKH C328
HKH C329
HKH C330
HKH C331



150 (5 $\frac{7}{8}$ ")
 100 (3 $\frac{15}{16}$ ")
 75 (2 $\frac{15}{16}$ ")
 50 (1 $\frac{15}{16}$ ")
 150 (5 $\frac{7}{8}$ ")
 100 (3 $\frac{15}{16}$ ")
 75 (2 $\frac{15}{16}$ ")
 50 (1 $\frac{15}{16}$ ")
 2440 x 212 (96 $\frac{1}{16}$ " x 8 $\frac{5}{16}$ ")
 2440 x 140 (96 $\frac{1}{16}$ " x 5 $\frac{1}{2}$ ")
 2440 x 106 (96 $\frac{1}{16}$ " x 4 $\frac{3}{16}$ ")
 2440 x 71 (96 $\frac{1}{16}$ " x 2 $\frac{3}{4}$ ")

UNIT = mm : inches

CORNICES

HKH C332



**HKH C333 (2T)
HKH C334 (1T)**

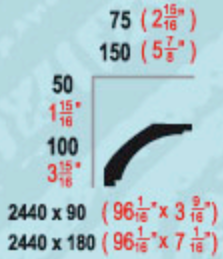

**HKH C335 (2C)
HKH C336 (1C)**



HKH C337 (TB1)

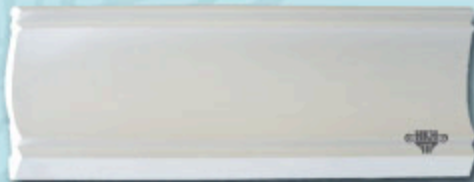

HKH C344



HKH C402

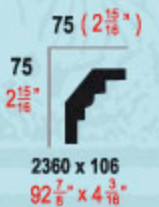

- HKH C400
- HKH C401
- HKH C403
- HKH C405
- HKH C406
- HKH C407
- HKH C408
- HKH C409
- HKH C410



- 120 (4 3/4")
- 60 (2 3/8")
- 75 (2 15/16")
- 100 (3 15/16")
- 40 (1 5/16")
- 150 (5 7/16")
- 200 (7 7/8")
- 75 (2 15/16")
- 100 (3 15/16")
- 300 (11 13/16")
- 40 (1 5/16")
- 150 (5 7/16")
- 200 (7 7/8")
- 250 (9 13/16")
- 300 (11 13/16")
- 2440 x 170 (96 1/16" x 6 11/16")
- 2330 x 85 (91 3/4" x 3 5/16")
- 2440 x 106 (96 1/16" x 4 3/16")
- 2440 x 142 (96 1/16" x 5 5/16")
- 2100 x 57 (82 11/16" x 2 1/4")
- 2440 x 213 (96 1/16" x 8 3/8")
- 2100 x 284 (82 11/16" x 11 3/16")
- 2100 x 355 (82 11/16" x 14")
- 2100 x 425 (82 11/16" x 16 11/16")

Website: www.hkhplaster.com

Website: www.hkhplaster.com

Website: www.hkhplaster.com

Website: www.hkhplaster.com

UNIT = mm : inches

CORNICES

HKN C404



HKH C444



HKH C412



HKH C445



**HKH C414
HKH C415**

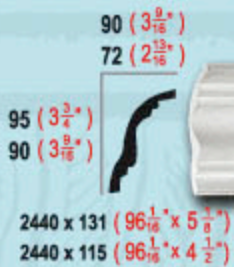

HKH C446



HKH C441



HKH C447



HKH C442



HKH C448



HKH C443



HKH C449



UNIT = mm : inches

CORNICES

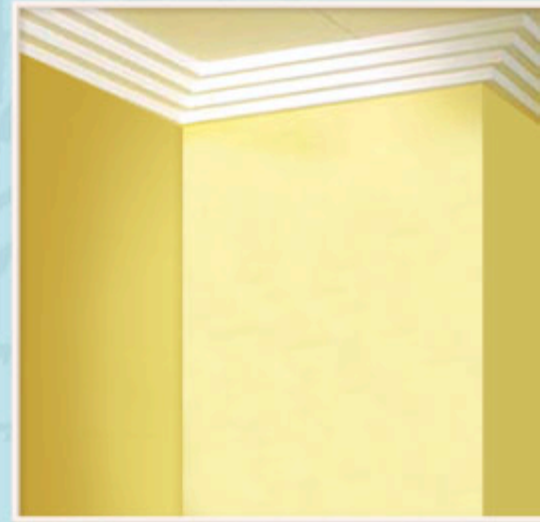
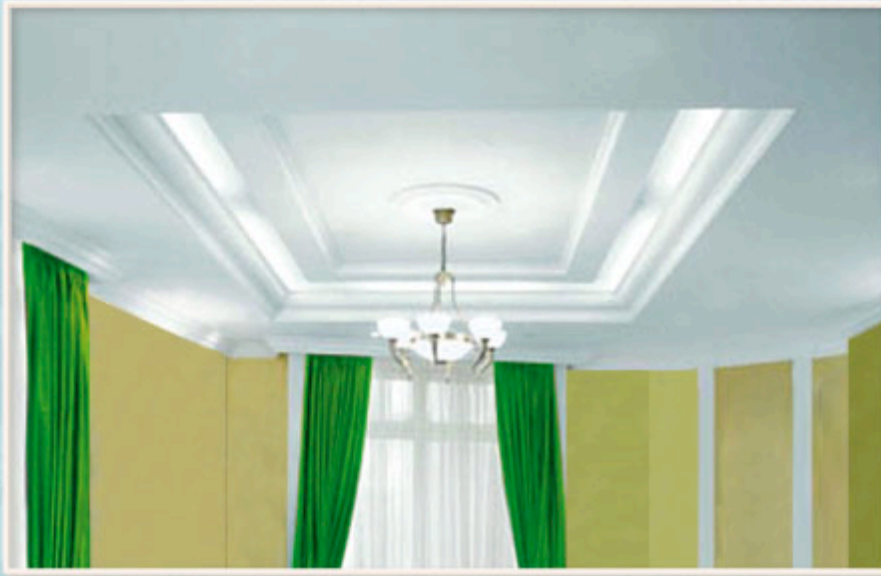

Website: www.hkhplaster.com

Website: www.hkhplaster.com

HKH C450

65 (2 ⁵/₁₆")
55
2 ¹/₈"
2020 x 85
79 ¹/₂" x 3 ⁵/₁₆"



HKH C451

65 (2 ⁵/₁₆")
105
4 ¹/₈"
2340 x 124
92 ¹/₈" x 4 ⁷/₈"



HKH C452

59 (2 ⁵/₁₆")
110
4 ⁵/₁₆"
2440 x 125
96 ¹/₁₆" x 4 ¹⁵/₁₆"



HKH C453

80 (3 ¹/₈")
120
3 ³/₄"
2440 x 145
96 ¹/₁₆" x 5 ¹¹/₁₆"



HKH C454



HKH C455



HKH C456



60 (2 ³/₈")
95
3 ³/₄"
2440 x 112
96 ¹/₁₆" x 4 ³/₈"

80 (3 ¹/₈")
90
3 ⁵/₁₆"
2440 x 120
96 ¹/₁₆" x 4 ³/₄"

75 (2 ¹⁵/₁₆")
90
3 ³/₁₆"
2440 x 117
96 ¹/₁₆" x 4 ⁵/₈"

Website: www.hkhplaster.com

Website: www.hkhplaster.com

UNIT = mm : inches

CORNICES

HKH C457



HKH C461



HKH C458



HKH C462



HKH C463



HKH C464



HKH C459



HKH C465



HKH C460



HKH C466



UNIT = mm : inches

CORNICES

HKH C467



2440 x 128
96 ¹/₁₆" x 5 ¹/₁₆"

HKH C473



2440 x 126
96 ¹/₁₆" x 4 ¹⁵/₁₆"

HKH C468



2440 x 136
96 ¹/₁₆" x 5 ³/₈"

HKH C474



2440 x 130
96 ¹/₁₆" x 5 ¹/₈"

HKH C469



2440 x 136
96 ¹/₁₆" x 5 ³/₈"

HKH C470



2440 x 136
96 ¹/₁₆" x 5 ³/₈"

HKH C471



2440 x 114
96 ¹/₁₆" x 4 ¹/₂"

HKH C475



2440 x 136
96 ¹/₁₆" x 5 ³/₈"

HKH C472



2440 x 112
96 ¹/₁₆" x 4 ¹³/₁₆"

HKH C476



2440 x 130
96 ¹/₁₆" x 5 ¹/₈"

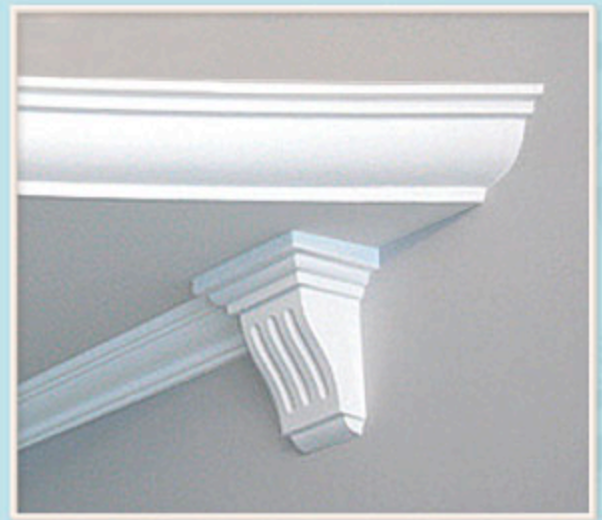

UNIT = mm : inches

CORNICES

HKH C477

80 (3 ¹/₈")
 100
 3 ¹⁵/₁₆"
 2440 x 128
 96 ¹/₁₆" x 5 ¹/₁₆"



HKH C478

67 (2 ⁵/₈")
 105
 4 ¹/₈"
 2440 x 125
 96 ¹/₁₆" x 4 ¹³/₁₆"



HKH C479

80 (3 ¹/₈")
 130
 5 ¹/₈"
 2440 x 153
 96 ¹/₁₆" x 6"



HKH C480

70 (2 ³/₄")
 85
 3 ⁵/₈"
 2440 x 110
 96 ¹/₁₆" x 4 ⁵/₁₆"



HKH C481

70 (2 ³/₄")
 100
 3 ¹⁵/₁₆"
 2440 x 122
 96 ¹/₁₆" x 4 ¹³/₁₆"



HKH C482

70 (2 ³/₄")
 100
 3 ¹⁵/₁₆"
 2440 x 122
 96 ¹/₁₆" x 4 ¹³/₁₆"



HKH C483



HKH C484



HKH C511



HKH C550



70 (2 ³/₄")
 110
 4 ⁵/₈"
 2440 x 130
 96 ¹/₁₆" x 5 ¹/₈"

70 (2 ³/₄")
 100
 3 ¹⁵/₁₆"
 2440 x 122
 96 ¹/₁₆" x 4 ¹³/₁₆"

115 (4 ¹/₂")
 120
 4 ³/₄"
 2340 x 166
 92 ¹/₈" x 6 ¹/₂"

115 (4 ¹/₂")
 162
 6 ³/₈"
 2210 x 199
 87" x 7 ¹³/₁₆"



Website: www.hkhplaster.com

Website: www.hkhplaster.com

Website: www.hkhplaster.com

Website: www.hkhplaster.com

Product designs are copyright reserved.

UNIT = mm : inches

CORNICES

HKH C555



HKH C665

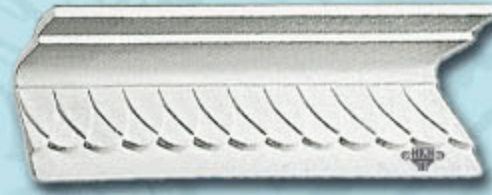

HKH C570



HKH C666



HKH C580A



HKH C667



HKH C580B



HKH C668



HKH C583



HKH C669



HKH C660



HKH C670



UNIT = mm : inches

CORNICES



Website: www.hkhplaster.com

**HKH C703A
HKH C703B
HKH C704**



70 (2 3/4")
100 (3 15/16")
53 (2 1/8")

70 (2 3/4")
100 (3 15/16")
53 (2 1/8")

2440 x 99 (96 1/8" x 3 7/8")
2440 x 141 (96 1/8" x 5 5/16")
2440 x 75 (96 1/8" x 2 11/16")

Website: www.hkhplaster.com

HKH C671

123 (4 11/16")
90 (3 5/8")

2330 x 152 (91 3/4" x 6")



Website: www.hkhplaster.com

HKH C707



83 (3 1/4")
93 (3 5/8")

2440 x 125 (96 1/8" x 4 15/16")

HKH C672

140 (5 1/2")
80 (3 1/8")

2330 x 161 (91 3/4" x 6 3/8")



**HKH C724
HKH C725
HKH C726**



60 (2 3/8")
60 (2 3/8")

2440 x 85 (96 1/8" x 3 3/8")

HKH C701

130 (5 1/8")
110 (4 5/16")

2440 x 170 (96 1/8" x 6 11/16")

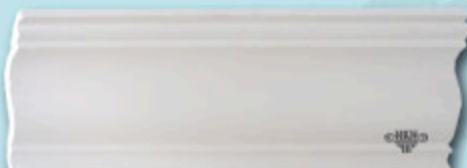

Website: www.hkhplaster.com

HKH C808



35 (1 3/8")
50 (1 15/16")
75 (2 11/16")

35 (1 3/8")
50 (1 15/16")
75 (2 11/16")

2100 x 50 (82 11/16" x 1 15/16")
2440 x 70 (96 1/8" x 2 3/4")
2440 x 105 (96 1/8" x 4 1/8")

HKH C702

98 (3 7/8")
110 (4 5/16")

2440 x 147 (96 1/8" x 5 13/16")



130 (5 1/8")
189 (7 5/16")

2360 x 229 (92 1/8" x 9")

UNIT = mm : inches

CORNICES

HKH C809



Website: www.hkhplaster.com

HKH C810



HKH C830



HKH C818



HKH C833



**HKH C820
HKH C821**



HKH C834



HKH C823



**HKH C835
HKH C836**



HKH C825



HKH C840



UNIT = mm : inches

CORNICES

HKH C844



HKH C875



HKH C845



HKH C880



HKH C850



HKH C855



HKH C860



HKH C885



HKH C870



HKH C886



Website: www.hkhplaster.com

Website: www.hkhplaster.com

Website: www.hkhplaster.com

Website: www.hkhplaster.com

Product designs are copyright reserved.

UNIT = mm : inches

CORNICES

HKH C888



HKH C892



HKH C889



HKH C893



HKH C890



HKH C894



HKH C895



HKH C891



UNIT = mm : inches

CORNICES

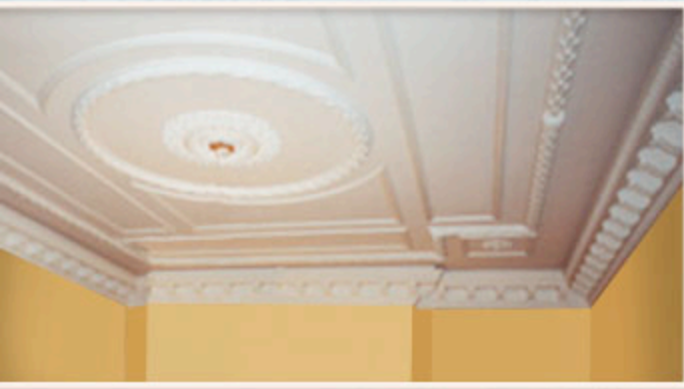

Website: www.hkhplaster.com

Website: www.hkhplaster.com

HKH C901
HKH C902



2320 x 210 (91 ⁵/₁₆\" x 8 ¹/₄\")
2300 x 290 (90 ⁹/₁₆\" x 11 ⁷/₁₆\")

HKH C911



2260 x 152
89\" x 5 ¹⁵/₁₆\"

HKH C913



2330 x 174
91 ³/₄\" x 6 ⁷/₈\"

HKH C920



2320 x 139
91 ⁵/₁₆\" x 5 ¹/₂\"

HKH C922



2360 x 212
92 ⁷/₈\" x 8 ⁵/₁₆\"

HKH C932



2360 x 212
92 ⁷/₈\" x 8 ⁵/₁₆\"

HKH C896



1950 x 210
76 ³/₄\" x 8 ¹/₄\"

HKH C897



2280 x 98
89 ³/₄\" x 3 ⁷/₈\"

HKH C898



2040 x 188
80 ⁵/₁₆\" x 7 ³/₈\"

HKH C899

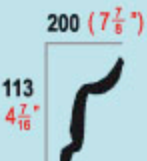

2000 x 230
78 ³/₄\" x 9 ¹/₁₆\"

HKH C900

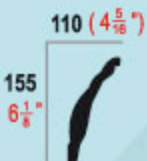

2260 x 190
89\" x 7 ¹/₂\"

UNIT = mm : inches

Product designs are copyright reserved.

CORNICES

HKH C936



2330 x 134
91 ³/₄" x 5 ¹/₄"

HKH C952



2330 x 193
91 ³/₄" x 7 ⁵/₈"

HKH C937



2350 x 144
92 ¹/₂" x 5 ¹¹/₁₆"

HKH C955

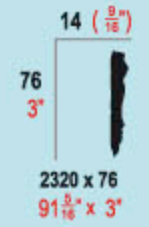

2320 x 76
91 ³/₈" x 3"

HKH C938



2340 x 147
92 ¹/₈" x 5 ¹³/₁₆"

HKH C939

HKH C949

HKH C959

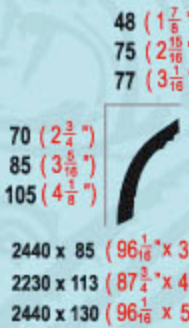

2440 x 85 (96 ¹/₁₆" x 3 ³/₁₆")
2230 x 113 (87 ³/₄" x 4 ⁷/₁₆")
2440 x 130 (96 ¹/₁₆" x 5 ¹/₈")

HKH C940



2360 x 135
92 ⁵/₈" x 5 ⁵/₁₆"

HKH C971



2330 x 78
91 ³/₄" x 3 ¹/₁₆"

HKH C950



2330 x 176
91 ³/₄" x 6 ¹⁵/₁₆"

HKH C972



2330 x 120
91 ³/₄" x 4 ³/₄"

UNIT = mm : inches

CORNICES

HKH C973



Website: www.hkhplaster.com

HKH C979



Website: www.hkhplaster.com

HKH C974



HKH C980



HKH C975



Website: www.hkhplaster.com

HKH C981



HKH C976



HKH C982



HKH C977



HKH C978

HKH C988



Website: www.hkhplaster.com



UNIT = mm : inches

CORNICES

HKH C991



HKH C992



HKH C993



HKH C994



HKH C995

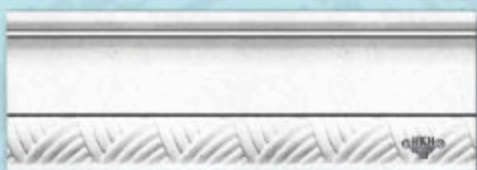

HKH C996



HKH C997



HKH C998



HKH C999



HKH WP12



UNIT = mm : inches

CORNICES



Website: www.hkhplaster.com

Website: www.hkhplaster.com

13 ($\frac{1}{2}$ "
130
 $5\frac{1}{8}$ "
2150 x 130
 $84\frac{5}{8}$ " x $5\frac{1}{8}$ "

HKH WP14



Website: www.hkhplaster.com

HKH WP18



32 ($1\frac{1}{4}$ "
105
 $4\frac{1}{8}$ "
1580 x 105
 $62\frac{3}{16}$ " x $4\frac{1}{8}$ "

10 ($\frac{3}{8}$ "
105
 $4\frac{1}{8}$ "
2015 x 105
 $79\frac{3}{8}$ " x $4\frac{1}{8}$ "

HKH WP15



HKH WP19



35 ($1\frac{3}{8}$ "
100
 $3\frac{15}{16}$ "
2320 x 100
 $91\frac{5}{16}$ " x $3\frac{15}{16}$ "

23 ($\frac{7}{8}$ "
105
 $4\frac{1}{8}$ "
1540 x 105
 $60\frac{5}{8}$ " x $4\frac{1}{8}$ "

HKH WP16



Website: www.hkhplaster.com

HKH WP20



12 ($\frac{1}{2}$ "
86
 $3\frac{3}{8}$ "
2370 x 86
 $93\frac{3}{16}$ " x $3\frac{3}{8}$ "

44 ($1\frac{3}{4}$ "
105
 $4\frac{1}{8}$ "
1690 x 105
 $66\frac{1}{2}$ " x $4\frac{1}{8}$ "

HKH WP17



Website: www.hkhplaster.com

HKH WP21



18 ($\frac{11}{16}$ "
73
 $2\frac{7}{8}$ "
2150 x 73
 $84\frac{5}{8}$ " x $2\frac{7}{8}$ "

UNIT = mm : inches

CORNICES

HKH WP27



HKH WP35

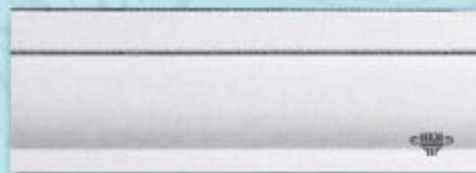

HKH WP28

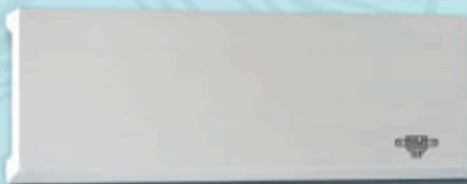
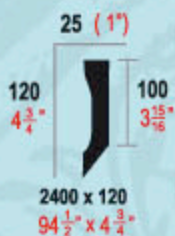

HKH WP36



**HKH WP29
HKH WP30**

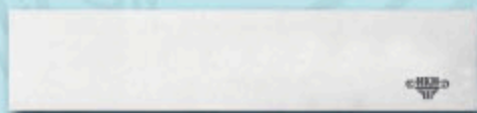
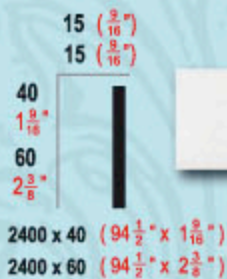

HKH WP979



UNIT = mm : inches

CORNICES EXTRA LENGTH

HKH ET1



Website: www.hkhplaster.com

HKH ET1R



Radius:
2580
8'-5 1/2"

Website: www.hkhplaster.com

Website: www.hkhplaster.com

400 (1'-3 3/4")
305
12"
2870 x 500
9'-1/2" x 1'-7 11/16"

HKH ET2



Website: www.hkhplaster.com

HKH ET775



150 (5 7/8")
150
5 7/8"
4000 x 210
13'-1 1/2" x 8 1/4"

292 (11 1/2")
254
10"
3000 x 385
9'-10" x 1'-3 1/8"

HKH ET M4



HKH ET776



100 (3 10/16")
80
3 1/8"
4000 x 125
13'-1 1/2" x 4 15/16"

104 (4 1/8")
195
7 11/16"
3000 x 220
9'-10" x 8 11/16"

HKH ET18



Website: www.hkhplaster.com

HKH ET777



135 (5 3/8")
90
3 9/16"
4000 x 160
13'-1 1/2" x 6 5/16"

102 (4")
127
5"
3000 x 165
9'-10" x 6 1/2"

UNIT = mm : inches

Website: www.hkhplaster.com

HKH ET M1
HKH ET M2
HKH ET M3
HKH ET M5
HKH ET M6



290 (11⁷/₁₆")
265 (10⁷/₁₆")
220 (8¹¹/₁₆")
145 (5¹¹/₁₆")
115 (4⁷/₂")

324 (12¹³/₁₆")
300 (11⁷/₈")
236 (9¹/₂")
160 (6⁵/₁₆")
145 (5¹¹/₁₆")



3000 x 435 (9'-10" x 1'-5¹/₄")
3000 x 400 (9'-10" x 1'-3¹⁵/₁₆")
3000 x 323 (9'-10" x 1'-11¹/₁₆")
3000 x 215 (9'-10" x 8⁷/₁₆")
3000 x 185 (9'-10" x 7⁵/₁₆")

Website: www.hkhplaster.com

HKH ET778

150 (5⁷/₈")
150 (5⁷/₈")
4000 x 210
13'-1¹/₂" x 8¹/₄"



HKH C168

110 (4⁵/₁₆")
153 (6")
3670 x 188
12'-1¹/₂" x 7³/₈"



HKH ET779

220 (8¹¹/₁₆")
150 (5⁷/₈")
4000 x 260
13'-1¹/₂" x 10¹/₄"



HKH C191

106 (4³/₁₆")
120 (4³/₄")
3600 x 160
11'-10¹¹/₁₆" x 6⁵/₁₆"



HKH C164

100 (3¹⁵/₁₆")
130 (5¹/₈")
3600 x 164
11'-10¹¹/₁₆" x 6⁷/₁₆"



HKH C235

105 (4¹/₈")
140 (5¹/₂")
3670 x 175
12'-1¹/₂" x 6⁷/₈"



HKH ET780

300 (11¹³/₁₆")
178 (7")
3710 x 350
12'-2¹/₁₆" x 13³/₄"



Website: www.hkhplaster.com

Website: www.hkhplaster.com

UNIT = mm : inches



CORNICES

EXTRA LENGTH

Website: www.hkhplaster.com

HKH C255



Website: www.hkhplaster.com

HKH C580A



HKH C669



HKH C310



Website: www.hkhplaster.com

HKH C670



HKH C320



HKH C671



HKH C444



Website: www.hkhplaster.com

HKH C672



HKH C550



HKH C820



Product designs are copyright reserved.

UNIT = mm : inches

HKH C830

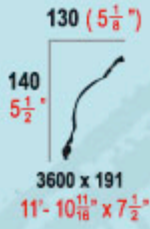

HKH C833

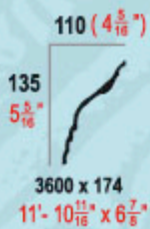

HKH C890



HKH C892



HKH C896



HKH C898



HKH C913



HKH C938



HKH C950



WP 89

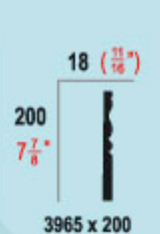

UNIT = mm : inches

CORNICES CORNERS



*G*ives elegant form, definition and aesthetic depth to bring out the best in corniced ceilings. From sleek lines of design to traditional elegance, cornice corners make a beautiful statement.

CORNICES CORNERS

UNIT = mm : inches

HKH 160/A

480 x 480 x 133 (18 $\frac{3}{8}$ " x 18 $\frac{3}{8}$ " x 5 $\frac{1}{4}$ ")



HKH 233/A

560 x 560 x 135 (22 $\frac{1}{16}$ " x 22 $\frac{1}{16}$ " x 5 $\frac{5}{16}$ ")



HKH 233/B

580 x 580 x 135 (22 $\frac{13}{16}$ " x 22 $\frac{13}{16}$ " x 5 $\frac{5}{16}$ ")



HKH 233/C

605 x 605 x 135 (23 $\frac{13}{16}$ " x 23 $\frac{13}{16}$ " x 5 $\frac{5}{16}$ ")



HKH 233/D

605 x 605 x 135 (23 $\frac{13}{16}$ " x 23 $\frac{13}{16}$ " x 5 $\frac{5}{16}$ ")



HKH 235/B

560 x 560 x 140 (22 $\frac{1}{16}$ " x 22 $\frac{1}{16}$ " x 5 $\frac{1}{2}$ ")



HKH 241/B

560 x 560 x 105 (22 $\frac{1}{16}$ " x 22 $\frac{1}{16}$ " x 4 $\frac{1}{8}$ ")



HKH 255/A

460 x 460 x 115 (18 $\frac{1}{8}$ " x 18 $\frac{1}{8}$ " x 4 $\frac{1}{2}$ ")



HKH 255/B

630 x 630 x 115 (24 $\frac{13}{16}$ " x 24 $\frac{13}{16}$ " x 4 $\frac{1}{2}$ ")



HKH 255/C

565 x 565 x 115 (22 $\frac{1}{2}$ " x 22 $\frac{1}{2}$ " x 4 $\frac{1}{2}$ ")

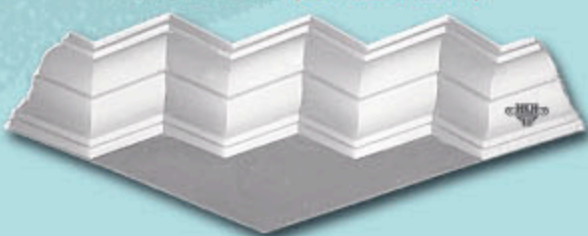

HKH 255/D

610 x 610 x 115 (24" x 24" x 4 $\frac{1}{2}$ ")

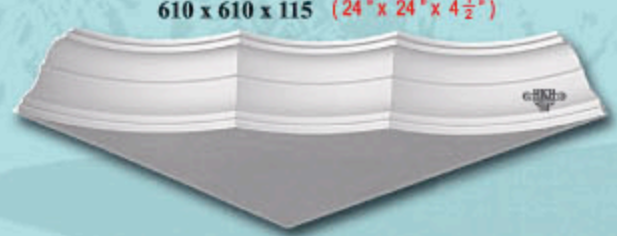

Corner HKH A-Z should be connected to cornice HKH C A-Z

CORNICES CORNERS

UNIT = mm : inches

HKH 255/E

640 x 640 x 115 (25 $\frac{3}{16}$ " x 25 $\frac{3}{16}$ " x 4 $\frac{1}{2}$ ")

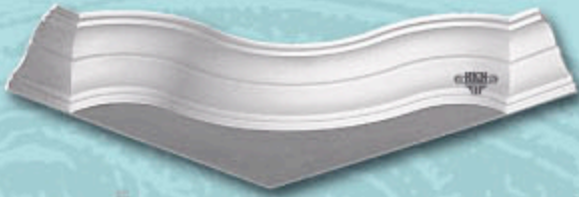

HKH 255/F

545 x 545 x 115 (21 $\frac{7}{16}$ " x 21 $\frac{7}{16}$ " x 4 $\frac{1}{2}$ ")



HKH 255/G

575 x 575 x 115 (22 $\frac{5}{8}$ " x 22 $\frac{5}{8}$ " x 4 $\frac{1}{2}$ ")

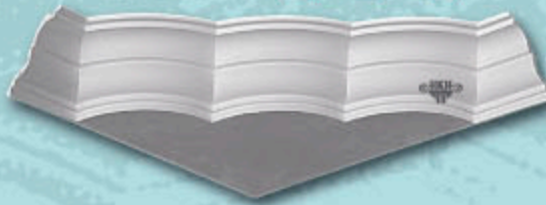

HKH 313/A

708 x 708 x 145 (27 $\frac{7}{8}$ " x 27 $\frac{7}{8}$ " x 5 $\frac{11}{16}$ ")



HKH 313/B

710 x 710 x 145 (27 $\frac{15}{16}$ " x 27 $\frac{15}{16}$ " x 5 $\frac{11}{16}$ ")



HKH 313/C

490 x 490 x 145 (19 $\frac{5}{16}$ " x 19 $\frac{5}{16}$ " x 5 $\frac{11}{16}$ ")



HKH 313/D

530 x 530 x 145 (20 $\frac{7}{8}$ " x 20 $\frac{7}{8}$ " x 5 $\frac{11}{16}$ ")



HKH 313/E

610 x 610 x 145 (24" x 24" x 5 $\frac{11}{16}$ ")



HKH 313/F(R)

610 x 750 x 145 (24" x 29 $\frac{1}{2}$ " x 5 $\frac{11}{16}$ ")



HKH 313/F(L)

610 x 750 x 145 (24" x 29 $\frac{1}{2}$ " x 5 $\frac{11}{16}$ ")



HKH 313/G

640 x 640 x 145 (25 $\frac{3}{16}$ " x 25 $\frac{3}{16}$ " x 5 $\frac{11}{16}$ ")



Corner HKH A-Z should be connected to cornice HKH C A-Z



UNIT = mm : inches

Website: www.hkhplaster.com

Website: www.hkhplaster.com

HKH 314/A(L)

780 x 600 x 105 (30¹¹/₁₆" x 23⁵/₈" x 4¹/₈"

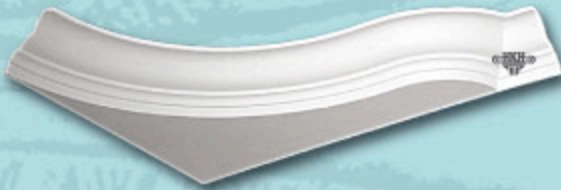

HKH 314/A(R)

780 x 600 x 105 (30¹¹/₁₆" x 23⁵/₈" x 4¹/₈"



HKH 314/B

680 x 680 x 105 (26³/₄" x 26³/₄" x 4¹/₈"



HKH 314/C

458 x 458 x 105 (18" x 18" x 4¹/₂"



HKH 314/D

510 x 510 x 105 (20¹/₁₆" x 20¹/₁₆" x 4¹/₈"



HKH 414/A

450 x 450 x 95 (17¹¹/₁₆" x 17¹¹/₁₆" x 3³/₄"



HKH 441/B

520 x 520 x 92 (20¹/₂" x 20¹/₂" x 3⁵/₈"



HKH 442/B

520 x 520 x 117 (20¹/₂" x 20¹/₂" x 4⁵/₈"



HKH 443/B

530 x 530 x 112 (20⁷/₈" x 20⁷/₈" x 4³/₈"



Corner HKH A-Z should be connected to cornice HKH C A-Z

Website: www.hkhplaster.com

Website: www.hkhplaster.com

Website: www.hkhplaster.com

Website: www.hkhplaster.com

Product designs are copyright reserved.

CORNICES CORNERS

UNIT = mm : inches

HKH 444/B

540 x 540 x 125 (21 $\frac{3}{4}$ " x 21 $\frac{3}{4}$ " x 4 $\frac{13}{16}$ ")



Website: www.hkhplaster.com

HKH 445/B

532 x 532 x 90 (20 $\frac{15}{16}$ " x 20 $\frac{15}{16}$ " x 3 $\frac{5}{16}$ ")



Website: www.hkhplaster.com

HKH 446/B

535 x 535 x 105 (21 $\frac{1}{16}$ " x 21 $\frac{1}{16}$ " x 4 $\frac{1}{8}$ ")



Website: www.hkhplaster.com

HKH 447/B

525 x 525 x 100 (20 $\frac{11}{16}$ " x 20 $\frac{11}{16}$ " x 3 $\frac{15}{16}$ ")



HKH 448/B

550 x 550 x 130 (21 $\frac{5}{8}$ " x 21 $\frac{5}{8}$ " x 5 $\frac{1}{8}$ ")



HKH 450/B

515 x 515 x 55 (20 $\frac{1}{4}$ " x 20 $\frac{1}{4}$ " x 2 $\frac{1}{8}$ ")



HKH 449/B

545 x 545 x 110 (21 $\frac{7}{16}$ " x 21 $\frac{7}{16}$ " x 4 $\frac{5}{16}$ ")



Website: www.hkhplaster.com

Corner HKH A-Z should be connected to cornice HKH C A-Z

CORNICES CORNERS

UNIT = mm : inches

HKH 451/B

515 x 515 x 105 (20 $\frac{1}{4}$ " x 20 $\frac{1}{4}$ " x 4 $\frac{1}{8}$ ")



HKH 452/B

515 x 515 x 110 (20 $\frac{1}{4}$ " x 20 $\frac{1}{4}$ " x 4 $\frac{3}{8}$ ")



HKH 453/B

530 x 530 x 120 (20 $\frac{7}{8}$ " x 20 $\frac{7}{8}$ " x 4 $\frac{3}{4}$ ")



HKH 454/B

520 x 520 x 95 (20 $\frac{1}{2}$ " x 20 $\frac{1}{2}$ " x 3 $\frac{3}{4}$ ")



HKH 455/B

530 x 530 x 90 (20 $\frac{7}{8}$ " x 20 $\frac{7}{8}$ " x 3 $\frac{5}{8}$ ")



HKH 456/B

525 x 525 x 90 (20 $\frac{11}{16}$ " x 20 $\frac{11}{16}$ " x 3 $\frac{5}{8}$ ")



HKH 457/B

520 x 520 x 90 (20 $\frac{1}{2}$ " x 20 $\frac{1}{2}$ " x 3 $\frac{5}{8}$ ")



HKH 458/B

497 x 497 x 100 (19 $\frac{5}{8}$ " x 19 $\frac{5}{8}$ " x 3 $\frac{15}{16}$ ")



HKH 459/B

510 x 510 x 100 (20 $\frac{1}{16}$ " x 20 $\frac{1}{16}$ " x 3 $\frac{15}{16}$ ")



HKH 460/B

530 x 530 x 100 (20 $\frac{7}{8}$ " x 20 $\frac{7}{8}$ " x 3 $\frac{15}{16}$ ")



HKH 461/B

510 x 510 x 100 (20 $\frac{1}{16}$ " x 20 $\frac{1}{16}$ " x 3 $\frac{15}{16}$ ")



Corner HKH A-Z should be connected to cornice HKH C A-Z

CORNICES CORNERS

UNIT = mm : inches

HKH 462/B

530 x 530 x 100 (20 $\frac{1}{8}$ " x 20 $\frac{7}{8}$ " x 3 $\frac{13}{16}$ ")



HKH 463/B

510 x 510 x 80 (20 $\frac{1}{16}$ " x 20 $\frac{1}{16}$ " x 3 $\frac{1}{8}$ ")



HKH 464/B

520 x 520 x 85 (20 $\frac{1}{2}$ " x 20 $\frac{1}{2}$ " x 3 $\frac{3}{16}$ ")



HKH 466/B

515 x 515 x 90 (20 $\frac{1}{4}$ " x 20 $\frac{1}{4}$ " x 3 $\frac{5}{16}$ ")



HKH 465/B

513 x 513 x 90 (20 $\frac{3}{16}$ " x 20 $\frac{3}{16}$ " x 3 $\frac{5}{16}$ ")



HKH 467/B

530 x 530 x 100 (20 $\frac{1}{8}$ " x 20 $\frac{7}{8}$ " x 3 $\frac{13}{16}$ ")



HKH 469/B

525 x 525 x 110 (20 $\frac{11}{16}$ " x 20 $\frac{11}{16}$ " x 4 $\frac{3}{16}$ ")



HKH 468/B

530 x 530 x 110 (20 $\frac{7}{8}$ " x 20 $\frac{7}{8}$ " x 4 $\frac{3}{16}$ ")



HKH 470/B

525 x 525 x 110 (20 $\frac{11}{16}$ " x 20 $\frac{11}{16}$ " x 4 $\frac{3}{16}$ ")



HKH 472/B

520 x 520 x 100 (20 $\frac{1}{2}$ " x 20 $\frac{1}{2}$ " x 3 $\frac{13}{16}$ ")



HKH 471/B

520 x 520 x 90 (20 $\frac{1}{2}$ " x 20 $\frac{1}{2}$ " x 3 $\frac{5}{16}$ ")



Corner HKH A-Z should be connected to cornice HKH C A-Z

CORNICES CORNERS



HKH 473/B

520 x 520 x 105 (20½" x 20½" x 4¼")



HKH 474/B

520 x 520 x 110 (20½" x 20½" x 4⅝")



HKH 475/B

530 x 530 x 110 (20⅞" x 20⅞" x 4⅝")



HKH 476/B

520 x 520 x 110 (20½" x 20½" x 4⅝")



HKH 477/B

530 x 530 x 100 (20⅞" x 20⅞" x 3⅝")



HKH 478/B

520 x 520 x 105 (20½" x 20½" x 4¼")



HKH 480/B

520 x 520 x 85 (20½" x 20½" x 3⅝")



HKH 481/B

520 x 520 x 100 (20½" x 20½" x 3⅝")



Corner HKH A-Z should be connected to cornice HKH C A-Z

CORNICES CORNERS

UNIT = mm : inches

HKH 482/B

520 x 520 x 100 (20½" x 20½" x 3⅞")



HKH 483/B

520 x 520 x 110 (20½" x 20½" x 4⅝")



HKH 555/A

680 x 680 x 170 (26¾" x 26¾" x 6⅞")



HKH 555/B

625 x 625 x 170 (24⅝" x 24⅝" x 6⅞")



HKH 580A/A

560 x 560 x 143 (22⅙" x 22⅙" x 5⅝")



HKH 580B/A

420 x 420 x 143 (16⅝" x 16⅝" x 5⅝")



HKH 580B/B

545 x 545 x 143 (21⅞" x 21⅞" x 5⅝")



HKH 580B/C

540 x 540 x 143 (21¼" x 21¼" x 5⅝")

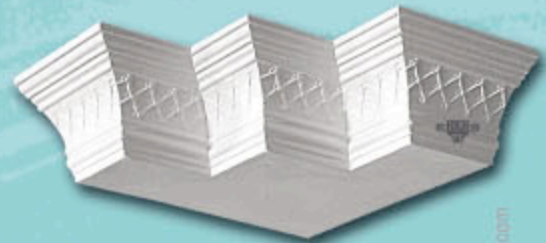

HKH 583/A(L)

755 x 630 x 120 (29⅙" x 24¾" x 4¾")



HKH 583/A(R)

755 x 630 x 120 (29⅙" x 24¾" x 4¾")



HKH 660/A

595 x 595 x 120 (23⅞" x 23⅞" x 4¾")



Corner HKH A-Z should be connected to cornice HKH C A-Z



Website: www.hkhplaster.com

HKH 667/B

540 x 540 x 130 (21 $\frac{1}{8}$ " x 21 $\frac{1}{8}$ " x 5 $\frac{1}{8}$ ")



Website: www.hkhplaster.com

HKH 668/B

550 x 550 x 133 (21 $\frac{5}{8}$ " x 21 $\frac{5}{8}$ " x 5 $\frac{1}{4}$ ")



HKH 669/B

530 x 530 x 117 (20 $\frac{7}{8}$ " x 20 $\frac{7}{8}$ " x 4 $\frac{5}{8}$ ")



Website: www.hkhplaster.com

HKH 670/B

555 x 555 x 122 (21 $\frac{7}{8}$ " x 21 $\frac{7}{8}$ " x 4 $\frac{11}{16}$ ")



Website: www.hkhplaster.com

HKH 671/B

540 x 540 x 123 (21 $\frac{1}{4}$ " x 21 $\frac{1}{4}$ " x 4 $\frac{13}{16}$ ")



HKH 672/B

530 x 530 x 140 (20 $\frac{7}{8}$ " x 20 $\frac{7}{8}$ " x 5 $\frac{1}{2}$ ")



Website: www.hkhplaster.com

HKH 818/A

510 x 510 x 130 (20 $\frac{1}{8}$ " x 20 $\frac{1}{8}$ " x 5 $\frac{1}{8}$ ")



Website: www.hkhplaster.com

HKH 818/B

585 x 585 x 130 (23" x 23" x 5 $\frac{1}{8}$ ")



Website: www.hkhplaster.com

Corner HKH A-Z should be connected to cornice HKH C A-Z

Product designs are copyright reserved.

CORNICES CORNERS

UNIT = mm : inches

HKH 818/C

575 x 575 x 130 (22⁵/₈" x 22⁵/₈" x 5¹/₈")



HKH 825/A

480 x 480 x 128 (18⁷/₈" x 18⁷/₈" x 5")



HKH 825/B

635 x 635 x 128 (25" x 25" x 5")



HKH 825/C

668 x 668 x 128 (26⁵/₁₆" x 26⁵/₁₆" x 5")



HKH 835/B

555 x 555 x 125 (21⁷/₈" x 21⁷/₈" x 4¹³/₁₆")



HKH 890/A

500 x 500 x 135 (19¹¹/₁₆" x 19¹¹/₁₆" x 5⁵/₁₆")



HKH 890/B

645 x 645 x 135 (25³/₈" x 25³/₈" x 5⁵/₁₆")



HKH 890/C

630 x 630 x 135 (24¹³/₁₆" x 24¹³/₁₆" x 5⁵/₁₆")



HKH 891/A

705 x 705 x 183 (27³/₄" x 27³/₄" x 7³/₁₆")



HKH 892/A

607 x 607 x 185 (23⁷/₈" x 23⁷/₈" x 7¹/₄")



HKH 892/C

845 x 845 x 185 (33¹/₄" x 33¹/₄" x 7¹/₄")



Corner HKH A-Z should be connected to cornice HKH C A-Z

Website: www.hkhplaster.com



Website: www.hkhplaster.com

HKH 893/A

370 x 370 x 97 (14 5/8" x 14 5/8" x 3 13/16")



HKH 893/B

520 x 520 x 97 (20 1/2" x 20 1/2" x 3 13/16")



HKH 894/B

520 x 520 x 103 (20 1/2" x 20 1/2" x 4 1/8")



HKH 895/B

510 x 510 x 95 (20 1/8" x 20 1/8" x 3 3/4")



HKH 894/A

375 x 375 x 103 (14 3/4" x 14 3/4" x 4 1/8")



HKH 895/A

460 x 460 x 95 (18 1/2" x 18 1/2" x 3 3/4")



HKH 896/A

600 x 600 x 165 (23 5/8" x 23 5/8" x 6 1/2")



Website: www.hkhplaster.com

Website: www.hkhplaster.com

Website: www.hkhplaster.com

Website: www.hkhplaster.com



Corner HKH A-Z should be connected to cornice HKH C A-Z

CORNICES CORNERS

UNIT = mm : inches

HKH 896/B

600 x 600 x 165 (23⁵/₈" x 23⁵/₈" x 6¹/₂")



Website: www.hkhplaster.com

HKH 896/C

735 x 735 x 165 (28¹⁵/₁₆" x 28¹⁵/₁₆" x 6¹/₂")



Website: www.hkhplaster.com

HKH 898/A

535 x 535 x 140 (21¹/₁₆" x 21¹/₁₆" x 5¹/₂")



Website: www.hkhplaster.com

Website: www.hkhplaster.com

HKH 898/B

740 x 740 x 140 (29¹/₈" x 29¹/₈" x 5¹/₂")



HKH 949/B

515 x 515 x 85 (20¹/₄" x 20¹/₄" x 3³/₁₆")

HKH 959/B

530 x 530 x 105 (20⁷/₈" x 20⁷/₈" x 4¹/₈")



HKH 972/A

455 x 455 x 90 (17⁷/₈" x 17⁷/₈" x 3⁵/₁₆")



Website: www.hkhplaster.com

Website: www.hkhplaster.com

HKH 972/B

550 x 550 x 90 (21⁵/₈" x 21⁵/₈" x 3⁵/₁₆")



HKH 972/C

625 x 625 x 90 (24⁵/₈" x 24⁵/₈" x 3⁵/₁₆")



HKH 975/A

460 x 460 x 100 (18¹/₈" x 18¹/₈" x 3¹⁵/₁₆")



Website: www.hkhplaster.com

HKH 975/B

535 x 535 x 100 (21¹/₁₆" x 21¹/₁₆" x 3¹⁵/₁₆")



Corner HKH A-Z should be connected to cornice HKH C A-Z

CORNICES CORNERS

UNIT = mm : inches

HKH 975/C

630 x 630 x 100 (24 $\frac{13}{16}$ " x 24 $\frac{13}{16}$ " x 3 $\frac{13}{16}$ ")



Website: www.hkhplaster.com

HKH 976/A

445 x 445 x 95 (17 $\frac{1}{2}$ " x 17 $\frac{1}{2}$ " x 3 $\frac{3}{4}$ ")



Website: www.hkhplaster.com

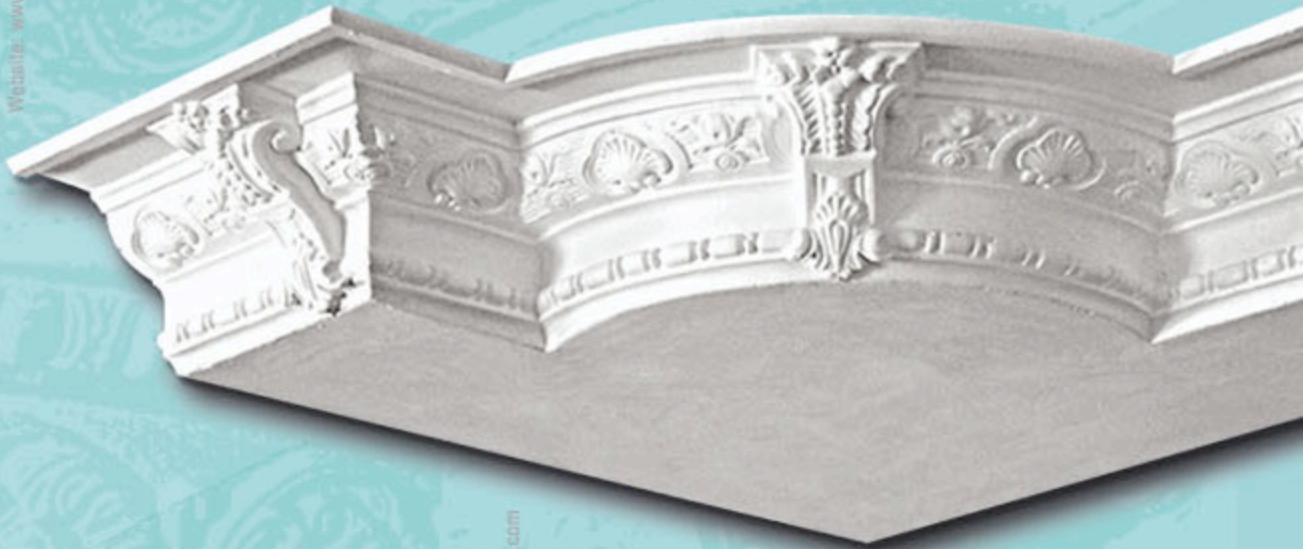

Website: www.hkhplaster.com

HKH 976/B

525 x 525 x 95 (20 $\frac{11}{16}$ " x 20 $\frac{11}{16}$ " x 3 $\frac{3}{4}$ ")



Website: www.hkhplaster.com

HKH 976/C

635 x 635 x 95 (25" x 25" x 3 $\frac{3}{4}$ ")



HKH 978/A

445 x 445 x 110 (17 $\frac{1}{2}$ " x 17 $\frac{1}{2}$ " x 4 $\frac{5}{16}$ ")



Website: www.hkhplaster.com

HKH 978/B

560 x 560 x 110 (22 $\frac{1}{16}$ " x 22 $\frac{1}{16}$ " x 4 $\frac{1}{16}$ ")

Website: www.hkhplaster.com

HKH 988/B

525 x 525 x 90 (20 $\frac{13}{16}$ " x 20 $\frac{13}{16}$ " x 3 $\frac{9}{16}$ ")



Website: www.hkhplaster.com

HKH 978/C

645 x 645 x 110 (25 $\frac{3}{8}$ " x 25 $\frac{3}{8}$ " x 4 $\frac{5}{16}$ ")



Website: www.hkhplaster.com

Corner HKH A-Z should be connected to cornice HKH C A-Z

CORNICES CORNERS

UNIT = mm : inches

HKH 979/A

465 x 465 x 115 (18⁵/₁₆" x 18⁵/₁₆" x 4¹/₂")



HKH 979/B

540 x 540 x 115 (21¹/₂" x 21¹/₂" x 4¹/₂")



HKH 979/C

615 x 615 x 115 (24³/₁₆" x 24³/₁₆" x 4¹/₂")



HKH 980/A

430 x 430 x 95 (16¹⁵/₁₆" x 16¹⁵/₁₆" x 3³/₄")



HKH 980/B

510 x 510 x 95 (20¹/₁₆" x 20¹/₁₆" x 3³/₄")



HKH 980/C

610 x 610 x 95 (24" x 24" x 3³/₄")



HKH 991/B

520 x 520 x 110 (20¹/₂" x 20¹/₂" x 4⁵/₁₆")



HKH 992/B

560 x 560 x 145 (22¹/₁₆" x 22¹/₁₆" x 5¹¹/₁₆")



HKH 993/B

520 x 520 x 85 (20¹/₂" x 20¹/₂" x 3⁵/₁₆")



Corner HKH A-Z should be connected to cornice HKH C A-Z

CORNICES CORNERS



Website: www.hkhplaster.com



Website: www.hkhplaster.com

HKH 994/B

520 x 520 x 85 (20 $\frac{1}{2}$ " x 20 $\frac{1}{2}$ " x 3 $\frac{5}{16}$ ")



Website: www.hkhplaster.com

HKH 995/B

530 x 530 x 105 (20 $\frac{7}{8}$ " x 20 $\frac{7}{8}$ " x 4 $\frac{1}{8}$ ")



Website: www.hkhplaster.com

HKH 996/B

535 x 535 x 110 (21 $\frac{1}{16}$ " x 21 $\frac{1}{16}$ " x 4 $\frac{5}{16}$ ")



Website: www.hkhplaster.com

HKH 997/B

530 x 530 x 110 (20 $\frac{7}{8}$ " x 20 $\frac{7}{8}$ " x 4 $\frac{5}{16}$ ")



Website: www.hkhplaster.com

HKH 998/B

526 x 526 x 105 (20 $\frac{11}{16}$ " x 20 $\frac{11}{16}$ " x 4 $\frac{1}{8}$ ")



Website: www.hkhplaster.com

HKH 999/B

525 x 525 x 100 (20 $\frac{11}{16}$ " x 20 $\frac{11}{16}$ " x 3 $\frac{15}{16}$ ")



Website: www.hkhplaster.com

HKH 168/B

560 x 560 x 153 (22 $\frac{1}{16}$ " x 22 $\frac{1}{16}$ " x 6")



Product designs are copyright reserved.

Corner HKH A-Z should be connected to cornice HKH C A-Z

CEILING ROSES

CEILING MEDALLIONS

CENTRE PANEL

C



Who can say no to ceiling roses? These intricate and exquisite works of art are every designer's dream. From the classic round shape to free-form designs, these alluring beauties always make the right impression.

CENTER PANEL / CEILING ROSES CEILING MEDALLIONS

UNIT = mm : inches



HKH CP1
Ø 620 (24 $\frac{7}{16}$ ")

Website: www.hkhplaster.com

Website: www.hkhplaster.com



HKH CP4
Ø 570 (22 $\frac{7}{16}$ ")

Website: www.hkhplaster.com

Website: www.hkhplaster.com



HKH CP5
Ø 450 (17 $\frac{11}{16}$ ")

Website: www.hkhplaster.com

Website: www.hkhplaster.com



HKH CP7
Ø 660 (26")

Website: www.hkhplaster.com

Website: www.hkhplaster.com



HKH CP8
Ø 930 x 660 (36 $\frac{3}{8}$ " x 26")

Website: www.hkhplaster.com



HKH CP9
Ø 840 x 610 (33 $\frac{1}{16}$ " x 24")

Product designs are copyright reserved.

CENTER PANEL / CEILING ROSES CEILING MEDALLIONS

UNIT = mm : inches



HKH CP17
Ø 460 (18 $\frac{1}{8}$ ")

Website: www.hkhplaster.com



HKH CP11
Ø 730 (28 $\frac{3}{4}$ ")

Website: www.hkhplaster.com



HKH CP16
Ø 620 (24 $\frac{7}{16}$ ")



HKH CP10
Ø 1140 (44 $\frac{7}{8}$ ")

Website: www.hkhplaster.com



HKH CP12
Ø 840 (33 $\frac{1}{8}$ ")

Website: www.hkhplaster.com



HKH CP14A
Ø 750 (29 $\frac{1}{2}$ ")

HKH CP14B
Ø 500 (19 $\frac{11}{16}$ ")

Website: www.hkhplaster.com

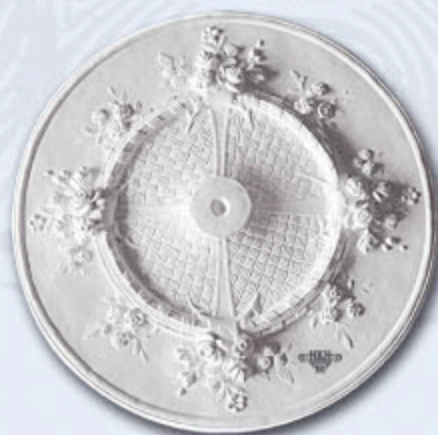

HKH CP15
Ø 650 (25 $\frac{8}{16}$ ")



HKH CP13
Ø 950 (37 $\frac{3}{8}$ ")

Product designs are copyright reserved.

UNIT = mm : inches



Website: www.hkhplaster.com



HKH CP18
Ø 940 (37")



HKH CP19
Ø 520 (20½")



HKH CP22
Ø 525 (20¹¹/₁₆")



HKH CP31
Ø 520 (20½")



HKH CP20
Ø 750 x 1100 (29½" x 43⁵/₁₆")

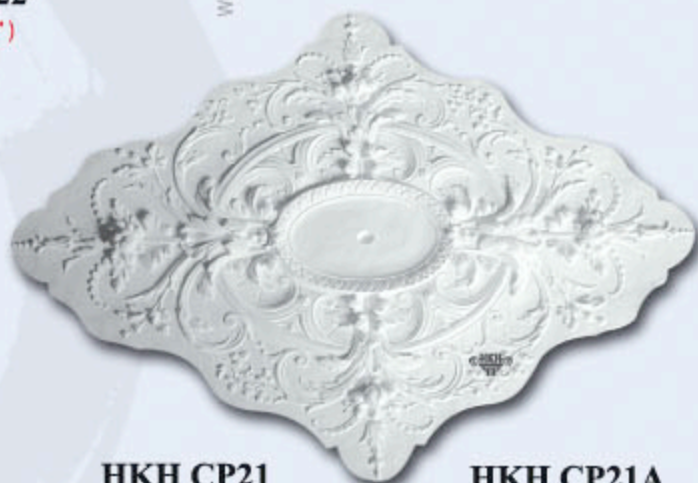

HKH CP21
Ø 950 x 1375 (37³/₈" x 54¹/₈")

HKH CP21A
Ø 780 x 1050 (30¹¹/₁₆" x 41³/₁₆")

Website: www.hkhplaster.com

Website: www.hkhplaster.com

Website: www.hkhplaster.com

Website: www.hkhplaster.com

Website: www.hkhplaster.com

Product designs are copyright reserved.

UNIT = mm : inches



HKH CP2A

Ø 925 (36⁷/₁₆"

HKH CP2B

Ø 1270 (50"

Website: www.hkhplaster.com



HKH CP23A

Ø 700 (27⁵/₁₆"

HKH CP23B

Ø 420 (16⁵/₁₆"

Website: www.hkhplaster.com



HKH CP29

Ø 180 (7¹/₈"

Website: www.hkhplaster.com

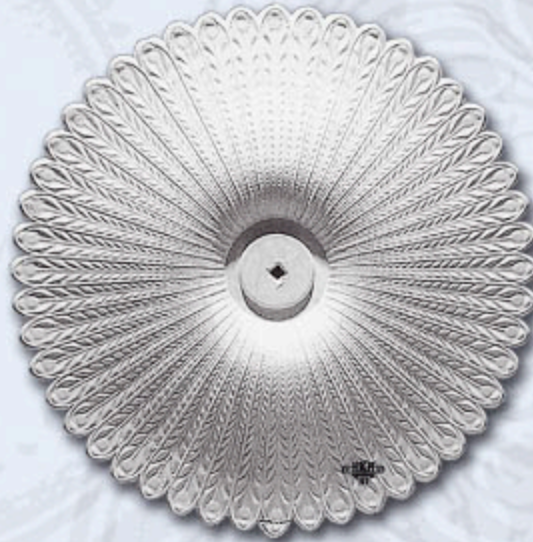

HKH CP25

Ø 930 (36⁵/₈"

Website: www.hkhplaster.com



HKH CP27A

Ø 500 (19¹¹/₁₆"

HKH CP27B

Ø 680 (26³/₄"



HKH CP32

Ø 895 (35¹/₄"

Product designs are copyright reserved.



HKH CP50

Ø 440 (17⁵/₁₆"

CENTER PANEL / CEILING ROSES CEILING MEDALLIONS

UNIT = mm : inches

HKH CP26A

Ø 1700 (66¹⁵/₁₆")

HKH CP26B

Ø 620 (24⁷/₁₆")

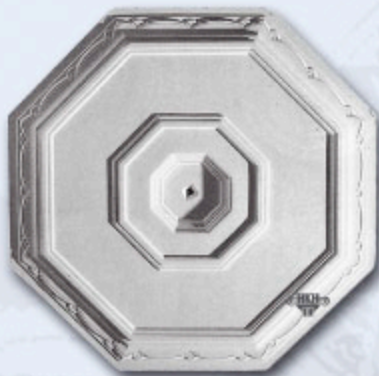

Website: www.hkhplaster.com

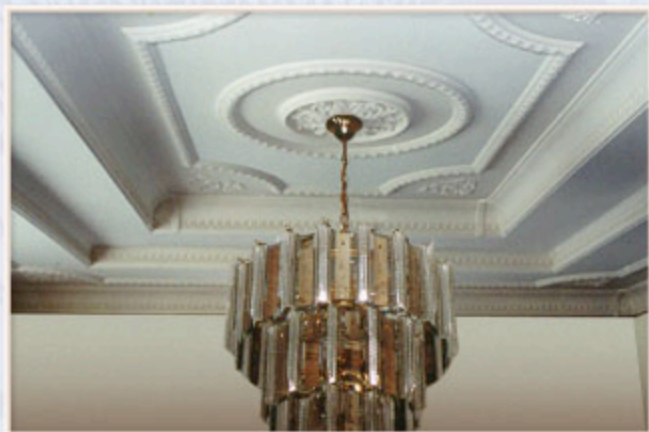

HKH CP24

Ø 490 (19⁵/₁₆")



HKH CP28

Ø 215 (8⁷/₁₆")

Website: www.hkhplaster.com



HKH CP35

Ø 1000 x 1000 (39³/₈" x 39³/₈")

Website: www.hkhplaster.com



HKH CP30

Ø 800 (31¹/₂")

Website: www.hkhplaster.com



HKH CP37

Ø 500 (19¹⁵/₁₆")

Website: www.hkhplaster.com



HKH CP39

Ø 600 (23⁵/₈")

Website: www.hkhplaster.com



HKH CP33A

Ø 440 (17¹⁵/₁₆")

HKH CP33B

Ø 680 (26³/₄")

Website: www.hkhplaster.com

Website: www.hkhplaster.com

Product designs are copyright reserved.

CENTER PANEL / CEILING ROSES CEILING MEDALLIONS

UNIT = mm : inches



Website: www.hkhplaster.com



HKH CP34
Ø 470 x 470 (18½" x 18½")



HKH CP38
Ø 830 (32½")

Website: www.hkhplaster.com



Website: www.hkhplaster.com

HKH CP36
Ø 560 x 560 (22¼" x 22¼")

Website: www.hkhplaster.com



HKH CP49
Ø 860 x 500 (33⅞" x 19⅜")

Website: www.hkhplaster.com



HKH CP40A
Ø 470 (18½")

HKH CP40B
Ø 680 (26¾")

Website: www.hkhplaster.com



HKH CP47
Ø 430 x 310 (16⅝" x 12⅜")



HKH CP41
Ø 750 (29½")

Website: www.hkhplaster.com



HKH CP44
Ø 520 (20½")

Website: www.hkhplaster.com



HKH CP46
Ø 760 (29⅝")

Website: www.hkhplaster.com



HKH CP42
Ø 660 (26")

Product designs are copyright reserved.

UNIT = mm : inches



HKH CP43
Ø 670 (26³/₈")

Website: www.hkhplaster.com

Website: www.hkhplaster.com



HKH CP45
Ø 950 (37³/₈")

Website: www.hkhplaster.com

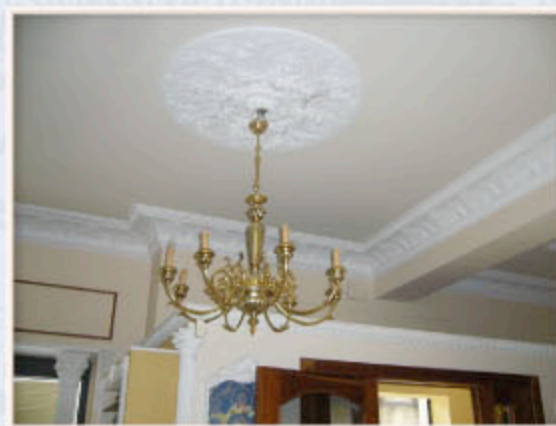

HKH CP48
Ø 830 (32⁵/₈")

Website: www.hkhplaster.com



HKH CP 51A
Ø 305 (12")

HKH CP 51B
Ø 600 (23⁵/₈")

HKH CP 51C
Ø 800 (31¹/₂")

Website: www.hkhplaster.com



HKH CP 52
Ø 290 (11³/₈")



HKH CP 53
Ø 890 (35¹/₈")

Website: www.hkhplaster.com

Website: www.hkhplaster.com



HKH CP54
Ø 840 (33¹/₈")

Product designs are copyright reserved.

CENTER PANEL / CEILING ROSES

UNIT = mm : inches



HKH CP55

Ø 830 (32¹¹/₁₆"*)
Ø 140 (5¹/₂"*)

Website: www.hkhplaster.com



HKH CP72

Ø 500 (19¹¹/₁₆"*)

Website: www.hkhplaster.com



HKH CP56

Ø 750 (29¹/₂"*)
Ø 150 (5⁷/₈"*)

Website: www.hkhplaster.com



HKH CP57

Ø 600 (23⁵/₈"*)

Website: www.hkhplaster.com



HKH CP58

Ø 450 (17¹¹/₁₆"*)

Website: www.hkhplaster.com



HKH CP59

Ø 500 (19¹¹/₁₆"*)

Website: www.hkhplaster.com



HKH CP60

Ø 300 (11¹³/₁₆"*)

Website: www.hkhplaster.com



HKH CP61A

Ø 480 (18⁷/₈"*)

HKH CP61B

Ø 800 (31¹/₂"*)



HKH CP62

Ø 480 (18⁷/₈"*)

Website: www.hkhplaster.com



HKH CP63

Ø 600 (23⁵/₈"*)

Product designs are copyright reserved.

CEILING MEDALLIONS

UNIT = mm : inches

Website: www.hkhplaster.com



HKH CP65

Ø 680 x 970 (26 $\frac{3}{4}$ " x 38 $\frac{3}{16}$ ")

Website: www.hkhplaster.com



HKH CP64

Ø 440 (17 $\frac{5}{16}$ ")

Website: www.hkhplaster.com



HKH CP66

Ø 825 x 1040 (32 $\frac{1}{2}$ " x 40 $\frac{15}{16}$ ")

Website: www.hkhplaster.com



HKH CP67

Ø 660 x 905 (26" x 35 $\frac{5}{8}$ ")



HKH CP 68A

Ø 520 (20 $\frac{1}{2}$ ")

HKH CP 68B

Ø 700 (27 $\frac{5}{8}$ ")

Website: www.hkhplaster.com

Website: www.hkhplaster.com



HKH CP 69A

Ø 565 (22 $\frac{1}{4}$ ")

HKH CP 69B

Ø 720 (28 $\frac{5}{16}$ ")

Website: www.hkhplaster.com



HKH CP 70A

Ø 450 (17 $\frac{11}{16}$ ")

HKH CP 70B

Ø 510 (20 $\frac{1}{16}$ ")

Website: www.hkhplaster.com



HKH CP 71

Ø 1130 (44 $\frac{1}{2}$ ")

	40 1 $\frac{5}{8}$ "		40 1 $\frac{5}{8}$ "
CP 70A	65 2 $\frac{5}{8}$ "	320 12 $\frac{3}{4}$ "	65 2 $\frac{5}{8}$ "
CP 70B	65 2 $\frac{5}{8}$ "	380 14 $\frac{15}{16}$ "	65 2 $\frac{5}{8}$ "

Product designs are copyright reserved.

COMPOSED CEILING MEDALLIONS

UNIT = mm : inches



Website: www.hkhplaster.com

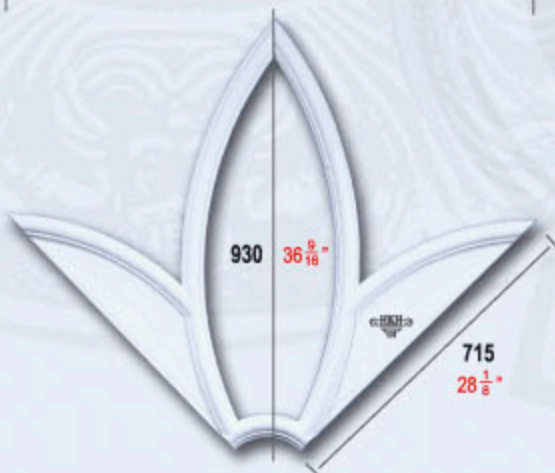
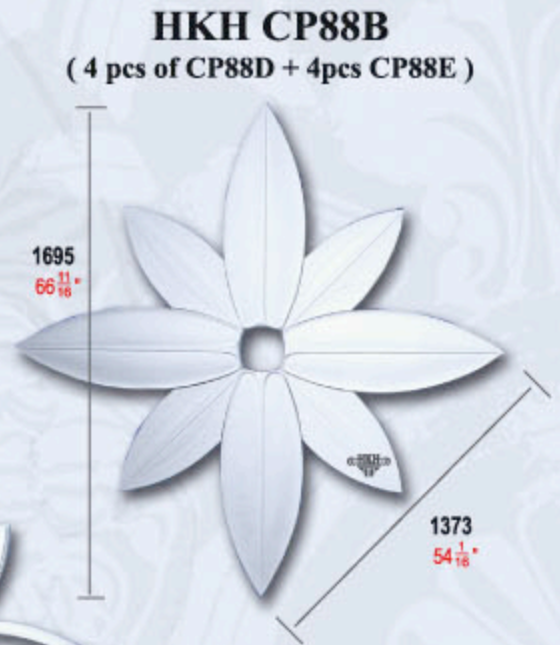
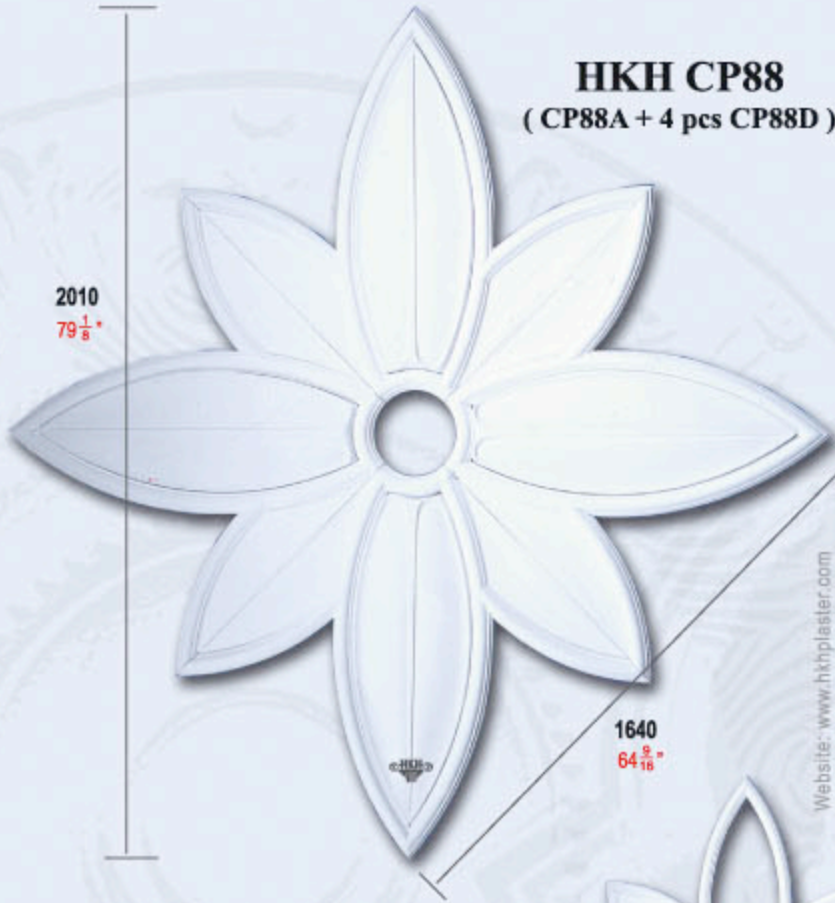

Product designs are copyright reserved.



HKH CP99

(3 pcs of CP99A + 6 pcs of CP99B + 1 pc of CP99D + 1 pc of CP99C)



1910
75 ³/₁₆"

HKH CP99A



930
36 ⁸/₁₆"

310 (12 ³/₁₆")

HKH CP99B



610
24"

460 (18 ¹/₂")

HKH CP99C



Ø 448
17 ⁵/₈"

Ø 627 (24 ¹¹/₁₆")

HKH CP99D



Ø 375 (14 ³/₄")



ES

BEADING & CURVING CORNERS

FRAMES



From walls to ceilings and doors, HKH frame mouldings visually enhance a room's sense of space by adding exquisite decorations that bring elegance and ambience to any décor. Panel mouldings with complementary crown and cornice moulding bring a harmonizing design to all living spaces.



FRAMES / BEADING & CURVING CORNERS

UNIT = mm : inches

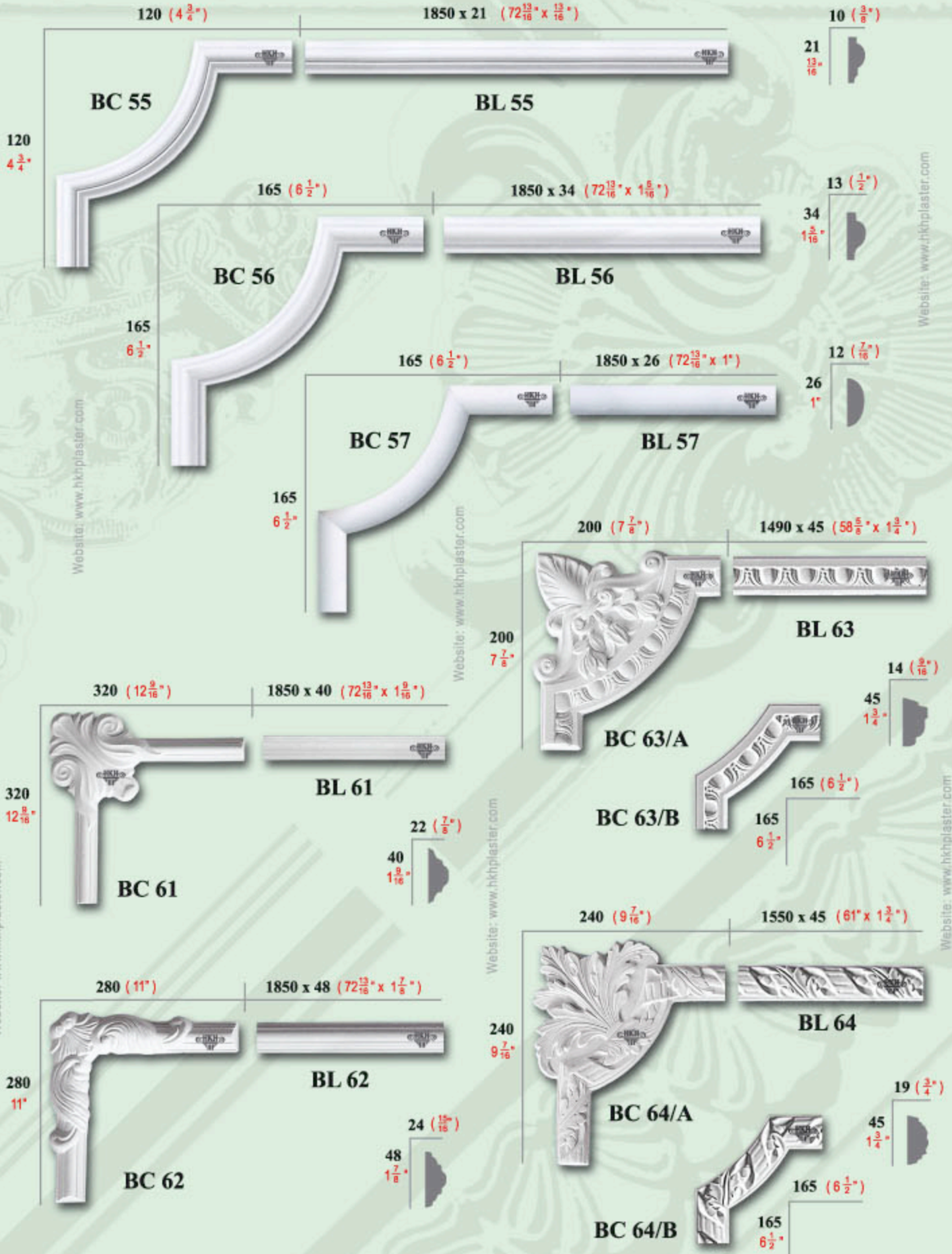

FRAMES / BEADING

UNIT = mm : inches



Website: www.hkhplaster.com

Website: www.hkhplaster.com

Website: www.hkhplaster.com

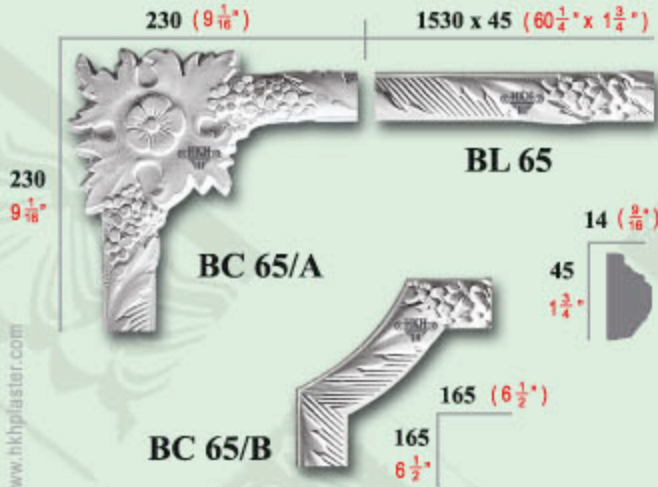

Website: www.hkhplaster.com

Website: www.hkhplaster.com

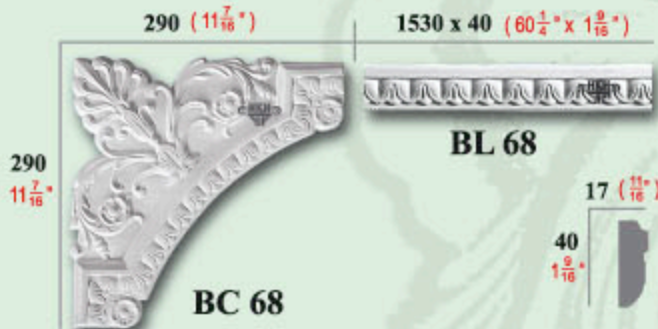
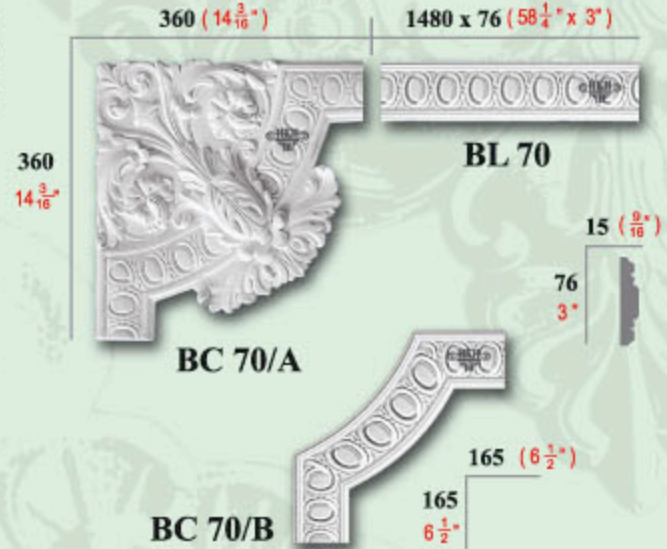
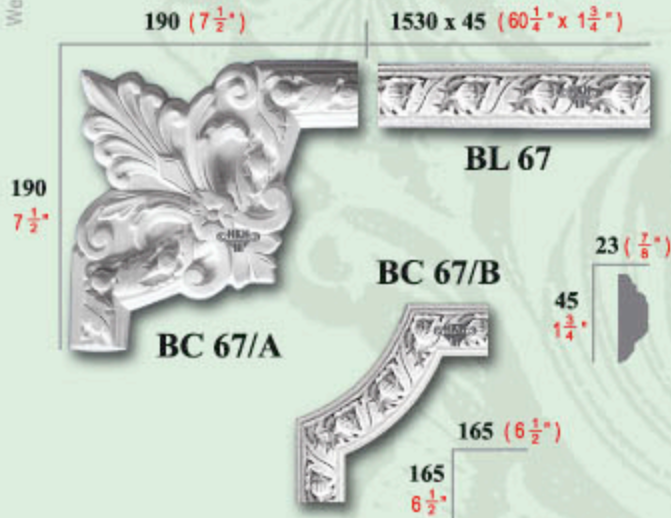

Website: www.hkhplaster.com

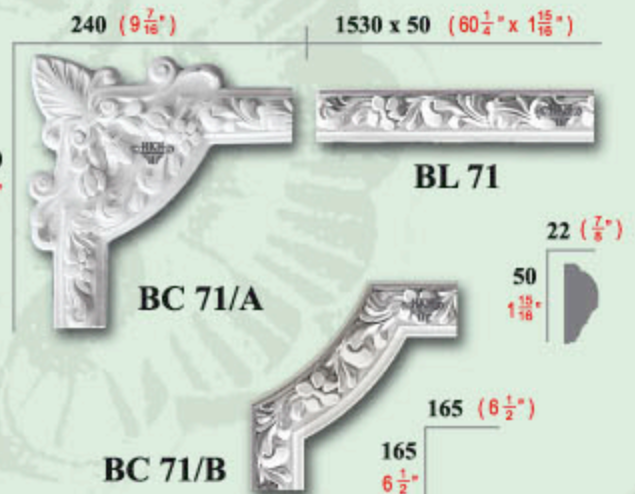

Product designs are copyright reserved.

✂ CURVING CORNERS

UNIT = mm : inches



Website: www.hkhplaster.com

Website: www.hkhplaster.com

Website: www.hkhplaster.com

Website: www.hkhplaster.com

Website: www.hkhplaster.com

Website: www.hkhplaster.com

Product designs are copyright reserved.

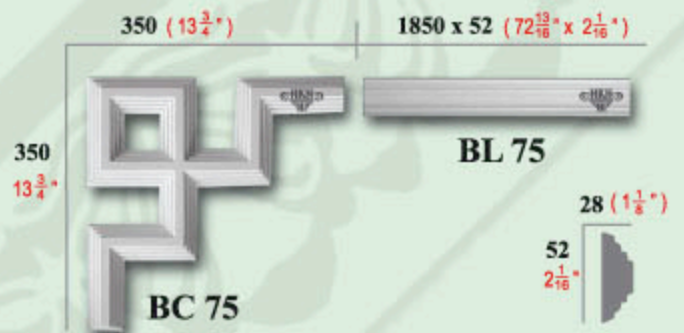
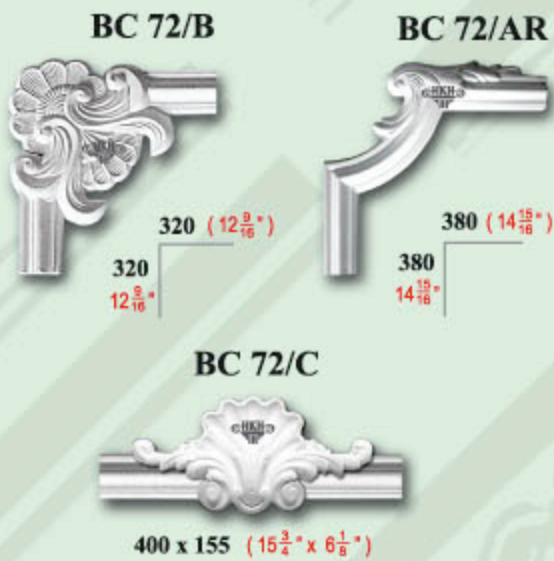
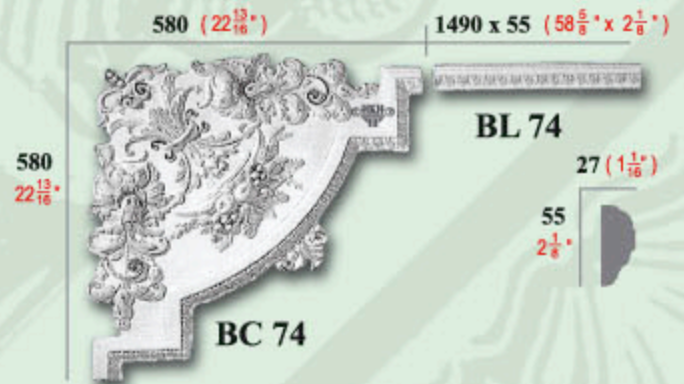
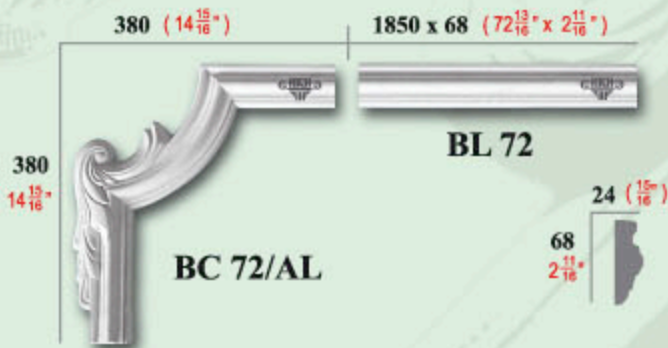

FRAMES / BEADING

UNIT = mm : inches

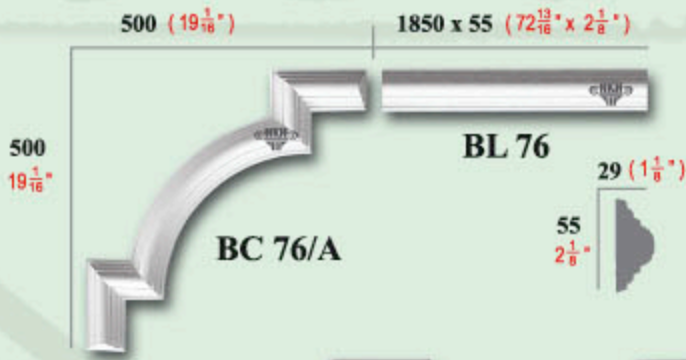

Website: www.hkhplaster.com

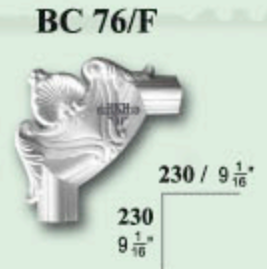

Website: www.hkhplaster.com

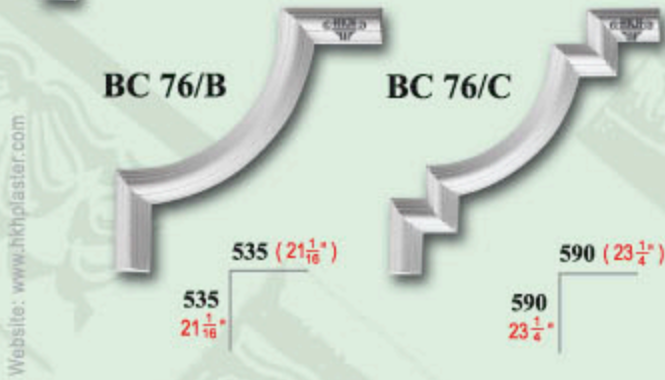

Website: www.hkhplaster.com

Website: www.hkhplaster.com

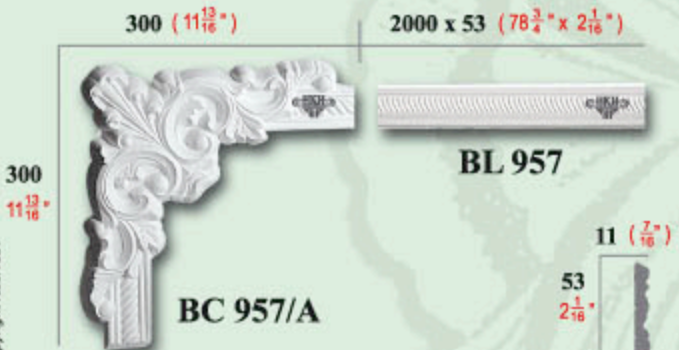
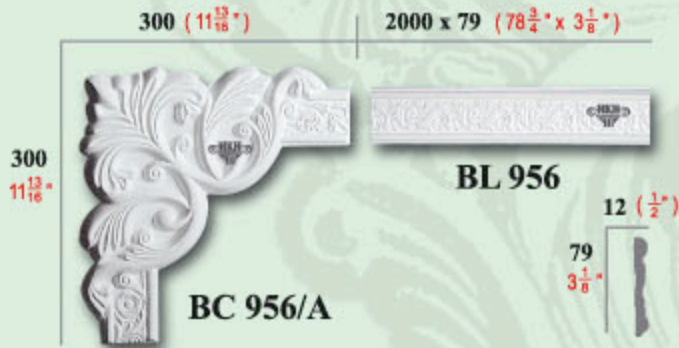

Website: www.hkhplaster.com

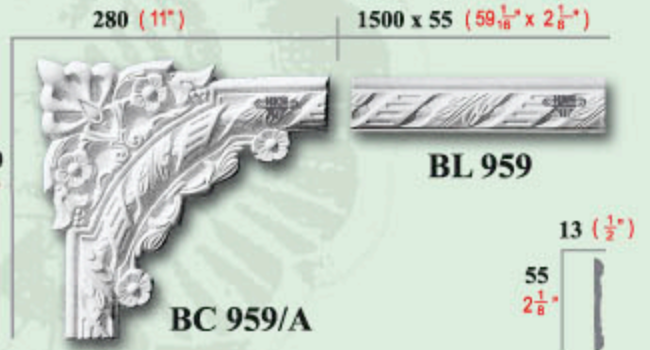

Product designs are copyright reserved.

✂ CURVING CORNERS

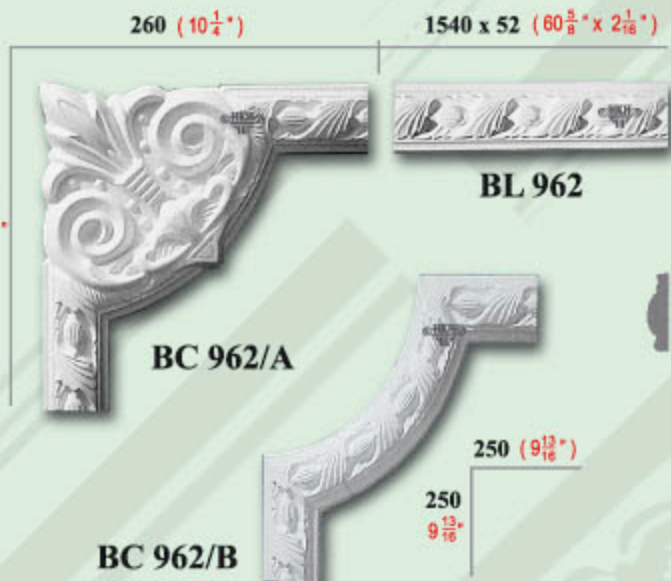
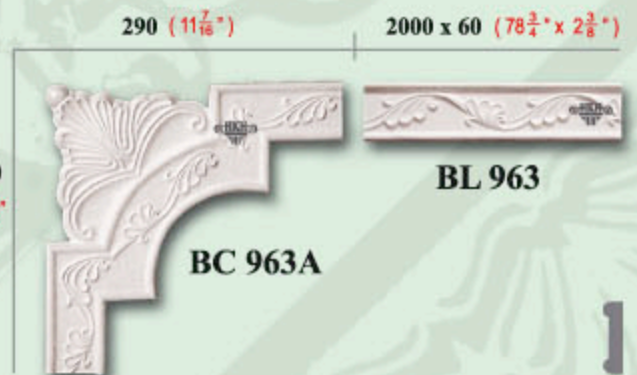
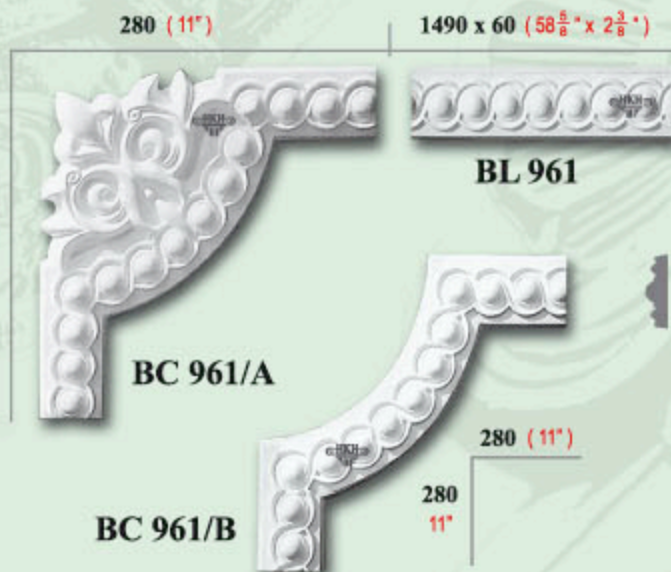
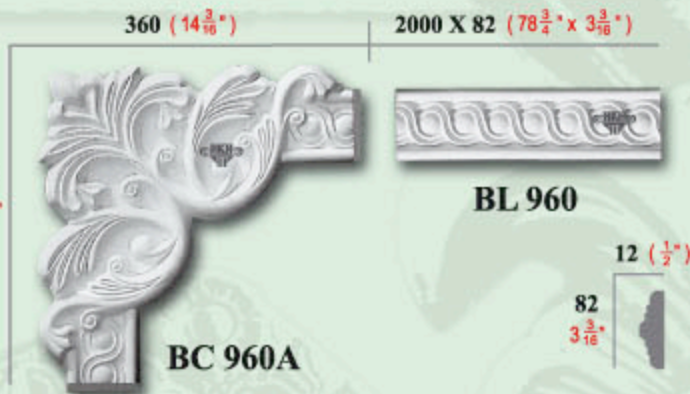

FRAMES / BEADING



Website: www.hkhplaster.com

Website: www.hkhplaster.com

300 (11 $\frac{13}{16}$ ")

2000 x 60 (78 $\frac{3}{4}$ " x 2 $\frac{3}{8}$ ")

300
11 $\frac{13}{16}$ "



BC 965A



BL 965

Website: www.hkhplaster.com

320 (12 $\frac{9}{16}$ ")

2000 X 55 (78 $\frac{3}{4}$ " x 2 $\frac{1}{8}$ ")

320
12 $\frac{9}{16}$ "



BC 966A

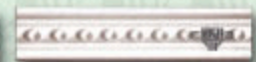

BL 966

Website: www.hkhplaster.com



HKH DS 4
80 x 80 x 20
3 $\frac{1}{8}$ " x 3 $\frac{1}{8}$ " x 1 $\frac{3}{16}$ "



HKH DS 5
80 x 80 x 20
3 $\frac{1}{8}$ " x 3 $\frac{1}{8}$ " x 1 $\frac{13}{16}$ "

Website: www.hkhplaster.com

HKH DS 1A



1275 x 160 (50 $\frac{3}{16}$ " x 6 $\frac{5}{16}$ ")

HKH DS 1



2440 x 80 (96 $\frac{1}{16}$ " x 3 $\frac{1}{8}$ ")

Website: www.hkhplaster.com

HKH DS 1B



1275 x 240 (50 $\frac{3}{16}$ " x 9 $\frac{7}{16}$ ")

HKH DS 1

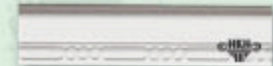

2440 x 80 (96 $\frac{1}{16}$ " x 3 $\frac{1}{8}$ ")

HKH DS 2A



1275 x 177 (50 $\frac{3}{16}$ " x 6 $\frac{15}{16}$ ")

HKH DS 2

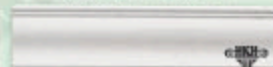

2440 x 125 (96 $\frac{1}{16}$ " x 4 $\frac{15}{16}$ ")

Product designs are copyright reserved.

✂ CURVING CORNERS

UNIT = mm : inches

HKH BL 81 (M21)



1850 x 60 (72¹³/₁₆" x 2³/₈")



HKH BL 82 (M24)



1850 x 40 (72¹³/₁₆" x 1⁵/₁₆")



HKH BL 84 (M34)



1850 x 25 (72¹³/₁₆" x 1")

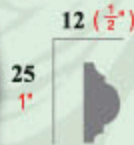

HKH BL 85 (M36)



1850 x 60 (72¹³/₁₆" x 2³/₈")

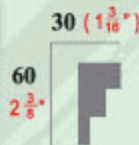

HKH BL 87 (M42)



1850 x 50 (72¹³/₁₆" x 1¹⁵/₁₆")



Website: www.hkhplaster.com

WP 13



1850 x 25 (72¹³/₁₆" x 1")

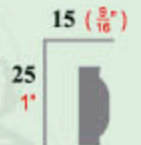

HKH WP 86 (M33)



2330 x 125 (91³/₄" x 4¹⁵/₁₆")



HKH WP 87 (M38)



2330 x 125 (91³/₄" x 4¹⁵/₁₆")



HKH WP 88 (M44)



2330 x 200 (91³/₄" x 7⁷/₈")



Website: www.hkhplaster.com

Product designs are copyright reserved.

UNIT = mm : inches

Website: www.hkhplaster.com

INSIDE & OUTSIDE VERTICAL CORNER MOULDINGS

Website: www.hkhplaster.com

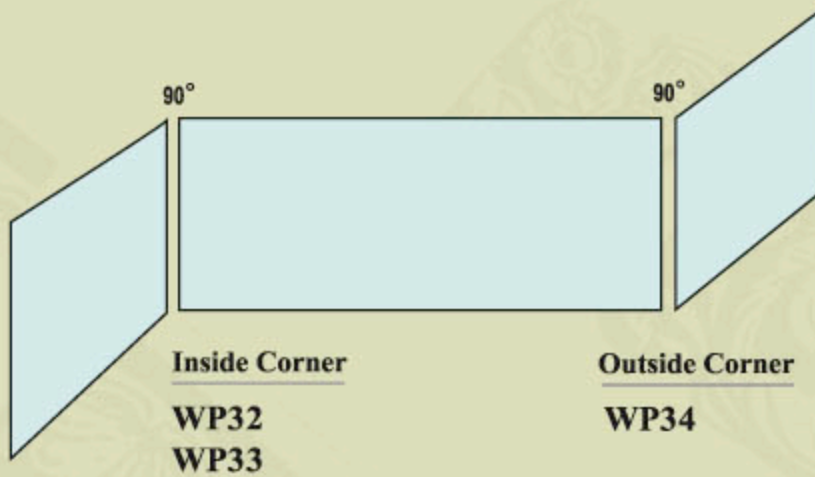

Website: www.hkhplaster.com

Website: www.hkhplaster.com

HKH WP32

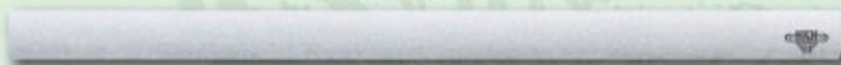

1850 x 15 (72 $\frac{13}{16}$ " x $\frac{9}{16}$ ")



HKH WP33



1850 x 37 (72 $\frac{13}{16}$ " x $1\frac{7}{16}$ ")

Website: www.hkhplaster.com



HKH WP34



1850 x 37 (72 $\frac{13}{16}$ " x $1\frac{7}{16}$ ")



Website: www.hkhplaster.com

Product designs are copyright reserved.

CURTAIN CORNICES MOULDINGS

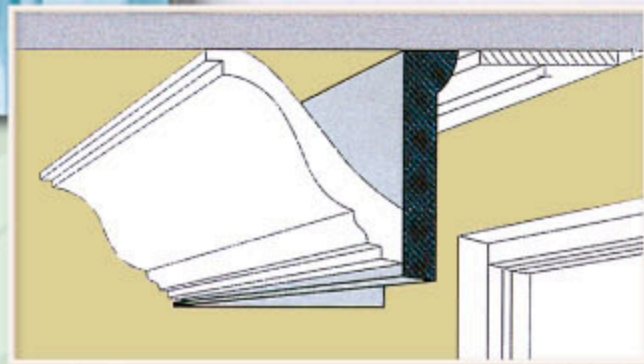

Website: www.hkhplaster.com

HKH CT120
2000 x 120 (78 ³/₄" x 4 ³/₈")

HKH CT150
2000 x 150 (78 ³/₄" x 5 ⁷/₈")

HKH CT180
2000 x 180 (78 ³/₄" x 7 ¹/₈")

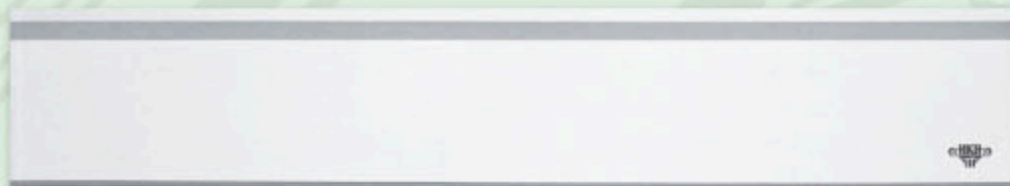

Website: www.hkhplaster.com

Website: www.hkhplaster.com

Website: www.hkhplaster.com

Product designs are copyright reserved.

DECORATIVE WALL PIECES

CORBELS, UPLIGHTERS

CURVING CORNERS,

FIRE SURROUND & NICHE



Decorative pieces that visually enhance and add aesthetic beauty to foyers, hallways and stairways. Adding corbels, framing corners and other decorative accessories to adjacent wall spaces bring gracious splendour to living spaces.

DECORATIVE WALL PIECES

UNIT = mm : Inches

Website: www.hkhplaster.com



HKH MR1
W500 x H850 x D125
 $19\frac{11}{16}'' \times 33\frac{7}{16}'' \times 4\frac{15}{16}''$

Website: www.hkhplaster.com

Website: www.hkhplaster.com



HKH MR2
W460 x H720 x D26
 $18\frac{1}{8}'' \times 28\frac{5}{16}'' \times 1''$

Website: www.hkhplaster.com

Website: www.hkhplaster.com



HKH MR4
W420 x H650 x D26
 $16\frac{2}{16}'' \times 25\frac{5}{16}'' \times 1''$



HKH MR3
W570 x H770 x D200
 $22\frac{7}{16}'' \times 30\frac{5}{16}'' \times 7\frac{7}{8}''$

Website: www.hkhplaster.com



HKH MR5
W450 x H730 x D130
 $17\frac{11}{16}'' \times 28\frac{3}{4}'' \times 5\frac{1}{8}''$



HKH MR6
W760 x H910 x D80
 $29\frac{15}{16}'' \times 35\frac{13}{16}'' \times 3\frac{1}{8}''$

DECORATIVE WALL PIECES / CORBELS

UNIT = mm : inches

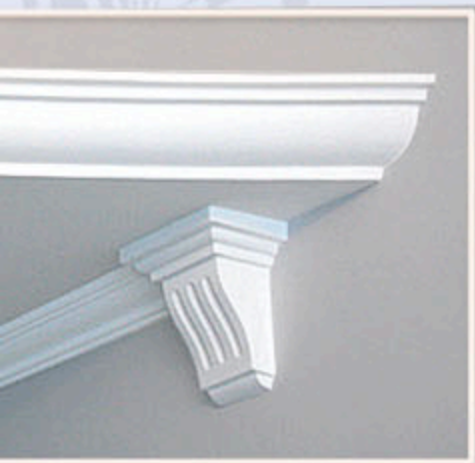

Website: www.hkhplaster.com



HKH CB1
W175 x H270 x D130
 $6\frac{7}{8}'' \times 10\frac{5}{8}'' \times 5\frac{1}{8}''$



HKH CB2
W155 x H165 x D100
 $6\frac{1}{8}'' \times 6\frac{1}{2}'' \times 3\frac{15}{16}''$

Website: www.hkhplaster.com

Website: www.hkhplaster.com



Website: www.hkhplaster.com

HKH CB3
W140 x H310 x D155
 $5\frac{1}{2}'' \times 12\frac{3}{8}'' \times 6\frac{1}{8}''$

Website: www.hkhplaster.com



HKH CB4
W290 x H200 x D210
 $11\frac{7}{16}'' \times 7\frac{7}{8}'' \times 8\frac{1}{4}''$

Website: www.hkhplaster.com



HKH CB7
W295 x H245 x D210
 $11\frac{5}{8}'' \times 9\frac{5}{8}'' \times 8\frac{1}{4}''$



HKH CB8
W95 x H165 x D85
 $3\frac{3}{4}'' \times 6\frac{1}{2}'' \times 3\frac{5}{8}''$



HKH CB10
W105 x H130 x D75
 $4\frac{1}{8}'' \times 5\frac{1}{8}'' \times 2\frac{15}{16}''$

Website: www.hkhplaster.com



HKH CB13
W155 x H275 x D135
 $6\frac{1}{8}'' \times 10\frac{13}{16}'' \times 5\frac{5}{16}''$

Product designs are copyright reserved.



HKH CB14
W130 x H260 x D70
5 $\frac{1}{8}$ " x 10 $\frac{1}{4}$ " x 2 $\frac{3}{4}$ "

Website: www.hkhplaster.com



HKH CB15
W130 x H165 x D70
5 $\frac{1}{8}$ " x 6 $\frac{1}{2}$ " x 2 $\frac{3}{4}$ "



HKH CB16
W110 x H165 x D58
4 $\frac{5}{8}$ " x 6 $\frac{1}{2}$ " x 2 $\frac{1}{4}$ "

Website: www.hkhplaster.com



HKH CB19
W220 x H520 x D135
8 $\frac{5}{8}$ " x 20 $\frac{1}{2}$ " x 5 $\frac{5}{8}$ "

Website: www.hkhplaster.com



HKH CB18
W75 x H125 x D40
2 $\frac{13}{16}$ " x 4 $\frac{13}{16}$ " x 1 $\frac{9}{16}$ "

Website: www.hkhplaster.com



HKH CB17
W215 x H385 x D125
8 $\frac{7}{16}$ " x 15 $\frac{1}{8}$ " x 4 $\frac{13}{16}$ "

Website: www.hkhplaster.com

Website: www.hkhplaster.com

HKH CB77
HKH CB78

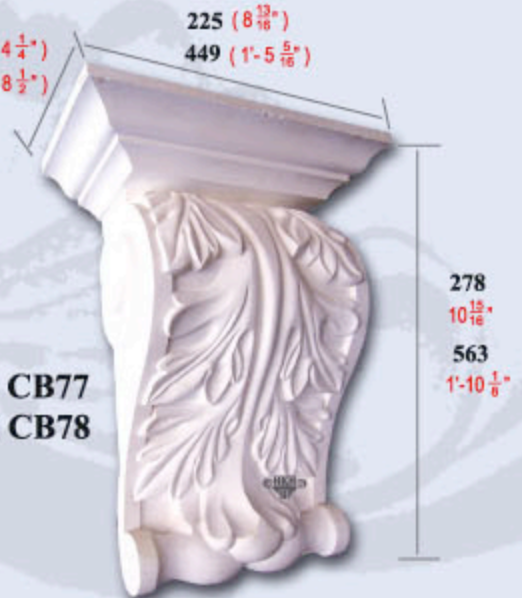

Product designs are copyright reserved.

DECORATIVE WALL PIECES / CORBELS /

UNIT = mm : inches



Website: www.hkhplaster.com

Website: www.hkhplaster.com



HKH CB6
H320 x W320 x D150
12³/₁₆" x 12³/₁₆" x 5⁷/₈"



HKH CB5
H215 x W240 x D215
8⁷/₁₆" x 9⁷/₁₆" x 8⁷/₁₆"



HKH CB9
H175 x W300 x D170
6⁷/₈" x 11¹³/₁₆" x 6¹¹/₁₆"



HKH FF1
250 x 135
9¹³/₁₆" x 5⁵/₁₆"



HKH FF2
300 x 300
11¹³/₁₆" x 11¹³/₁₆"



HKH FF4
380 x 210
14¹⁵/₁₆" x 8¹/₄"



HKH FF3
560 x 240
22¹/₈" x 9⁷/₁₆"



HKH FF5
355 x 150
13¹⁵/₁₆" x 5⁷/₈"

Website: www.hkhplaster.com

Website: www.hkhplaster.com

Website: www.hkhplaster.com

Website: www.hkhplaster.com

Website: www.hkhplaster.com

Product designs are copyright reserved.

CURVING CORNERS

UNIT = mm : inches

290 (11 ⁷/₁₆"*)

290 (11 ⁷/₁₆"*)

290
11 ⁷/₁₆"*

290
11 ⁷/₁₆"*

HKH FF6

Website: www.hkhplaster.com



HKH FF7

375 x 160

14 ³/₄"* x 6 ⁵/₈"*

Website: www.hkhplaster.com



HKH FF8

260 x 260

10 ¹/₄"* x 10 ¹/₄"*

Website: www.hkhplaster.com



HKH FF9

600 x 180

23 ⁵/₈"* x 7 ¹/₈"*

Website: www.hkhplaster.com



HKH FF10

500 x 240 x 30

19 ¹¹/₁₆"* x 9 ⁷/₁₆"* x 1 ³/₁₆"*

Product designs are copyright reserved.



HKH WP10

450 x 220

17 ¹¹/₁₆"* x 8 ⁵/₈"*



HKH WP11

280 x 100

11" x 3 ¹⁵/₁₆"*

DECORATIVE WALL PIECES



Website: www.hkhplaster.com

Website: www.hkhplaster.com

Website: www.hkhplaster.com



HKH WP25

400 x 295 x 30

15 $\frac{3}{4}$ " x 11 $\frac{5}{8}$ " x 1 $\frac{3}{16}$ "

Website: www.hkhplaster.com



HKH WP1

1350 x 350 x 25 (53 $\frac{1}{8}$ " x 13 $\frac{3}{4}$ " x 1")

Website: www.hkhplaster.com



HKH WP22

1030 x 345 x 25 (40 $\frac{8}{16}$ " x 13 $\frac{5}{16}$ " x 1")

Website: www.hkhplaster.com



HKH WP26

510 x 235 x 30 (20 $\frac{1}{16}$ " x 9 $\frac{3}{4}$ " x 1 $\frac{3}{16}$ "



HKH WP23

1230 x 400 x 25 (48 $\frac{7}{16}$ " x 15 $\frac{3}{4}$ " x 1")

Product designs are copyright reserved.

UNIT = mm : inches



Website: www.hkhplaster.com



HKH LT1
290 x 145 x 170
11⁷/₁₆" x 5¹¹/₁₆" x 6¹¹/₁₆"

Website: www.hkhplaster.com



HKH LT2
260 x 130 x 290
10¹/₄" x 5¹/₈" x 11⁷/₁₆"

Website: www.hkhplaster.com



HKH LT3
420 x 210 x 130
16⁹/₁₆" x 8¹/₄" x 5¹/₈"

Website: www.hkhplaster.com



HKH LT4
505 x 200 x 175
19⁷/₈" x 7⁷/₈" x 6⁷/₈"

Product designs are copyright reserved.



Website: www.hkhplaster.com

HKH WP24
655 x 765 x 15
25³/₄" x 30¹/₈" x ⁵/₈"

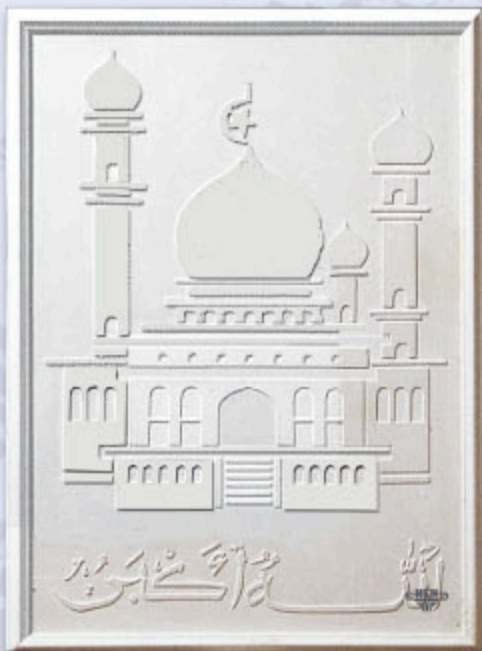

Website: www.hkhplaster.com

HKH WP2
975 x 725 x 15
38³/₈" x 28¹/₂" x ⁵/₈"

DECORATIVE UPLIGHTER &

UNIT = mm : inches



HKH LT7
W215 x H230
8 ⁷/₁₆" x 9 ¹/₁₆"



HKH LT8
W215 x H230
8 ⁷/₁₆" x 9 ¹/₁₆"



HKH LT5
370 x 185 x 380
14 ⁹/₁₆" x 7 ¹/₄" x 14 ¹⁵/₁₆"



HKH LT6
370 x 185 x 380
14 ⁹/₁₆" x 7 ¹/₄" x 14 ¹⁵/₁₆"

1350 (53 ¹/₂")

FB3 155 (6 ¹/₈")

FB4 280 (11")

315
12 ³/₈"

670
26 ³/₈"

210
8 ¹/₄"

FB3 90 (3 ⁵/₁₆")

FB4 215 (8 ⁵/₁₆")



160 (6 ³/₁₆")

900 (35 ⁷/₁₆")

160 (6 ³/₁₆")

HKH FB3
HKH FB4

Product designs are copyright reserved.

FIRE SURROUND

UNIT = mm : inches



HKH LT9
W415 x H225 x D180
16 $\frac{5}{16}$ " x 8 $\frac{7}{8}$ " x 7 $\frac{1}{16}$ "



HKH LT10
W415 x H225 x D180
16 $\frac{5}{16}$ " x 8 $\frac{7}{8}$ " x 7 $\frac{1}{16}$ "



HKH CB11
W300 x H270 x D110
11 $\frac{13}{16}$ " x 10 $\frac{5}{8}$ " x 4 $\frac{5}{16}$ "



HKH CB12
W330 x H220 x D110
13" x 8 $\frac{5}{8}$ " x 4 $\frac{5}{16}$ "

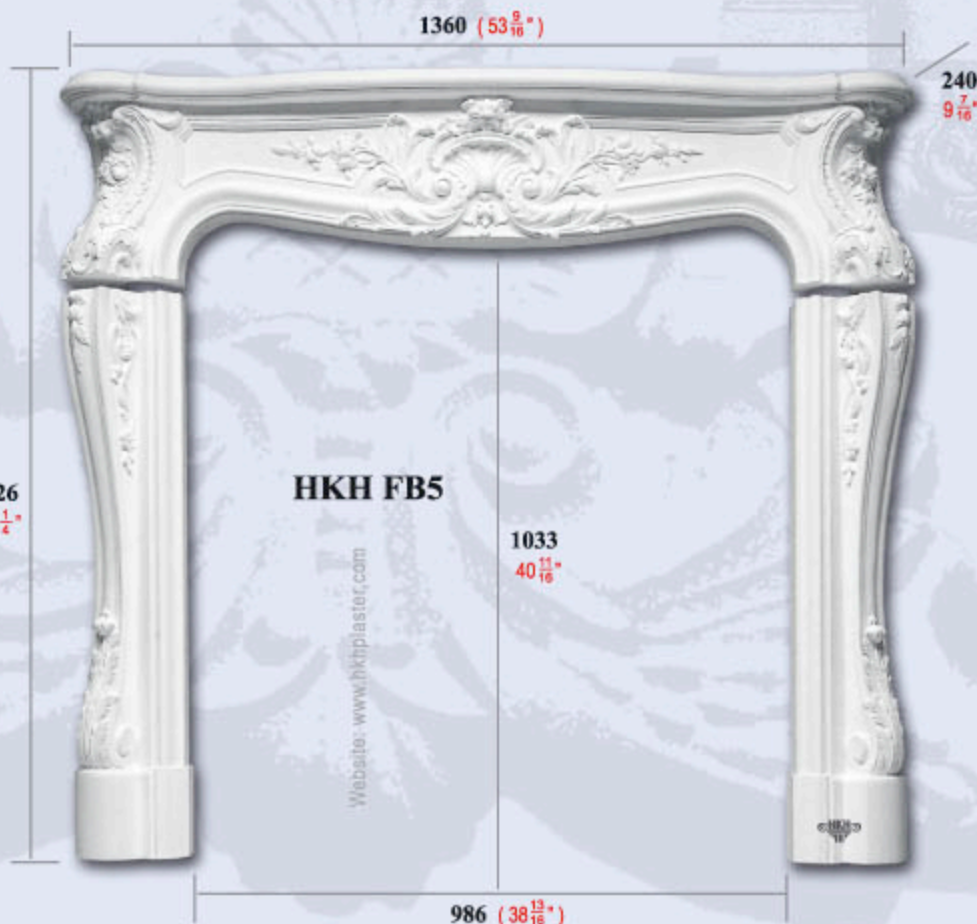

LIGHTING HOLDER

& CORNERS

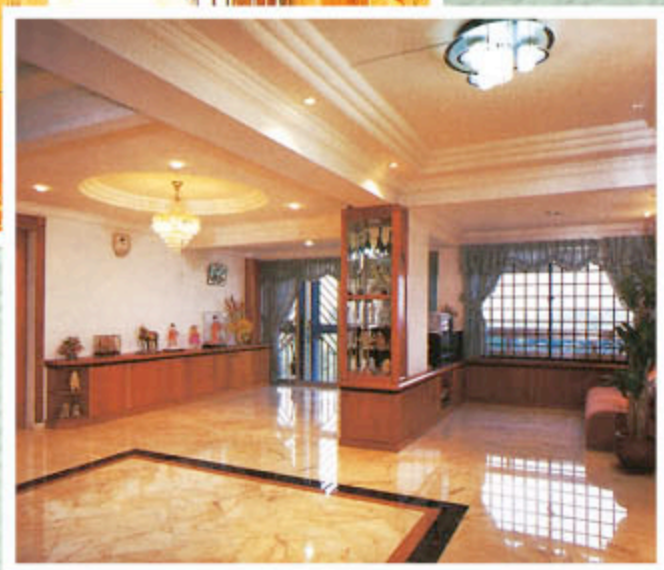

Enhances lighted spaces with depth and warm elegance. Light up your world in every imaginable way with these essential accessories.

LIGHTING HOLDER/CORNERS



UNIT = mm : inches

Website: www.hkhplaster.com

Website: www.hkhplaster.com

HKH LH 100 L=2360 (92 $\frac{7}{8}$ "*)

HKH LH 150 L=2360 (92 $\frac{7}{8}$ "*)

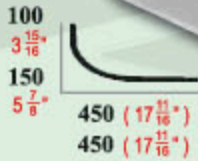

HKH LH 921

L=2360 (92 $\frac{7}{8}$ "*)



HKH LH 255

L=2360 (92 $\frac{7}{8}$ "*)



HKH LH 922

L=2360 (92 $\frac{7}{8}$ "*)



HKH LH 313

L=2360 (92 $\frac{7}{8}$ "*)



HKH LH 923

L=2360 (92 $\frac{7}{8}$ "*)



HKH LH 414

L=2360 (92 $\frac{7}{8}$ "*)



HKH LH 924

L=2330 (91 $\frac{3}{4}$ "*)

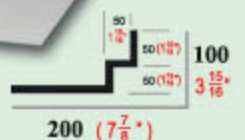

Corner LH A-Z to connect with Lighting Holder LH A-Z

LIGHTING HOLDER / CORNERS

UNIT = mm : inches

HKH LH 932

L=2360 (92 $\frac{7}{8}$ ")



HKH LH 932/A

875 x 875 x 130 (34 $\frac{7}{16}$ " x 34 $\frac{7}{16}$ " x 5 $\frac{1}{8}$ ")



HKH LH 944

L=1830 (72")

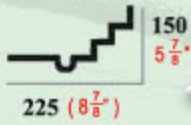

HKH LH 100/A

840 x 840 x 100 (33 $\frac{1}{16}$ " x 33 $\frac{1}{16}$ " x 3 $\frac{15}{16}$ ")

HKH LH 150/A

840 x 840 x 150 (33 $\frac{1}{16}$ " x 33 $\frac{1}{16}$ " x 5 $\frac{7}{8}$ ")



HKH LH 921/A

920 x 920 x 150 (36 $\frac{3}{16}$ " x 36 $\frac{3}{16}$ " x 5 $\frac{7}{8}$ ")



HKH LH 921/B

925 x 925 x 150 (36 $\frac{7}{16}$ " x 36 $\frac{7}{16}$ " x 5 $\frac{7}{8}$ ")



HKH LH 255/A

880 x 880 x 115 (34 $\frac{5}{8}$ " x 34 $\frac{5}{8}$ " x 4 $\frac{1}{2}$ ")



HKH LH 922/A

870 x 870 x 150 (34 $\frac{1}{4}$ " x 34 $\frac{1}{4}$ " x 5 $\frac{7}{8}$ ")



HKH LH 313/A

880 x 880 x 145 (34 $\frac{5}{8}$ " x 34 $\frac{5}{8}$ " x 5 $\frac{11}{16}$ ")



HKH LH 922/B

890 x 890 x 150 (35" x 35" x 5 $\frac{7}{8}$ ")



HKH LH 414/A

900 x 900 x 95 (35 $\frac{7}{16}$ " x 35 $\frac{7}{16}$ " x 3 $\frac{3}{4}$ ")



Corner LH A-Z to connect with Lighting Holder LH A-Z



HKH LH 922/C

900 x 900 x 150 (35 7/16" x 35 7/16" x 5 7/8")



HKH LH 932/C

900 x 900 x 130 (35 7/16" x 35 7/16" x 5 1/8")



HKH LH 922/D

600 x 600 x 150 (23 5/8" x 23 5/8" x 5 7/8")



HKH LH 932/D

900 x 900 x 130 (35 7/16" x 35 7/16" x 5 1/8")



HKH LH 932/B

1000 x 1000 x 130 (39 3/8" x 39 3/8" x 5 1/8")



HKH LH 932/E

920 x 920 x 130 (36 3/8" x 36 3/8" x 5 1/8")



HKH LH 944/A

750 x 750 x 150 (29 1/2" x 29 1/2" x 5 7/8")



Corner LH A-Z to connect with Lighting Holder LH A-Z

CEILING & WALL

RELIEF CAMEO & BOARD

PANELS



*R*adiate a welcoming ambience with an assortment of decorative ceiling panels. Exquisite designs fire the imagination and transform every room ceiling into a new height of elegance.

CEILING PANELS

UNIT = mm : inches

Website: www.hkhplaster.com



HKH P401
780 x 780 x 90
30¹¹/₁₆" x 30¹¹/₁₆" x 3⁹/₁₆"

Website: www.hkhplaster.com



HKH P403
920 x 920 x 90
36³/₁₆" x 36³/₁₆" x 3⁹/₁₆"

Website: www.hkhplaster.com

Website: www.hkhplaster.com



HKH P402
380 x 380 x 70
14¹⁵/₁₆" x 14¹⁵/₁₆" x 2³/₄"

Website: www.hkhplaster.com

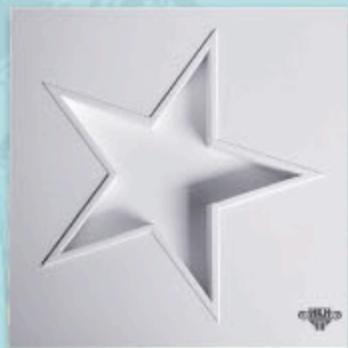

HKH P405
645 x 645 x 70
25³/₈" x 25³/₈" x 2³/₄"

Website: www.hkhplaster.com



HKH P404

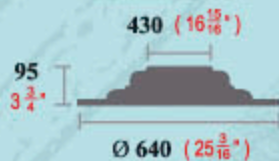

Website: www.hkhplaster.com



HKH P406
670 x 670 x 65
26³/₈" x 26³/₈" x 2⁵/₁₆"

Website: www.hkhplaster.com



HKH P407
760 x 500 x 70 (29¹³/₁₆" x 19¹¹/₁₆" x 2³/₄")

HKH P408
610 x 430 x 70 (24" x 16¹⁵/₁₆" x 2³/₄")

Website: www.hkhplaster.com



HKH P409
100 x 1200 (3¹⁵/₁₆" x 47¹/₄")

HKH P410
100 x 600 (3¹⁵/₁₆" x 23³/₈")

Product designs are copyright reserved.

CEILING & WALL PANELS / RELIEF

UNIT = mm : Inches

Website: www.hkhplaster.com

80 (3 1/8") 140 (5 1/2")



HKH P415

610 x 610 x 30 (24" x 24" x 1 3/16")

HKH P416

1200 x 1200 x 50 (47 1/4" x 47 1/4" x 1 15/16")

Website: www.hkhplaster.com



Website: www.hkhplaster.com



Thickness
25 (1")

HKH P412

Ø 530 x 410 (20 7/8" x 16 1/8")

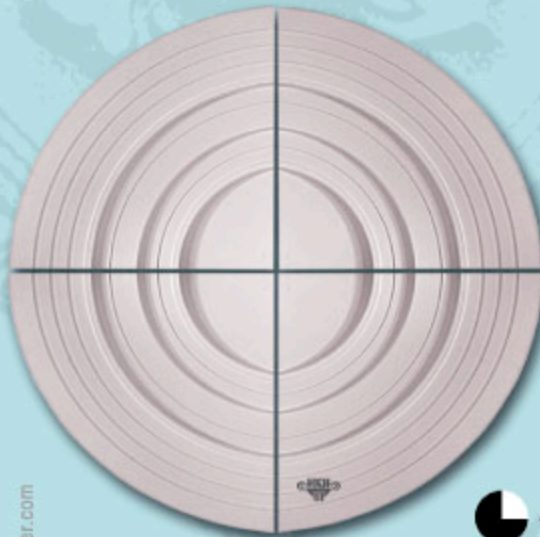

HKH P420

Ø 2220 (87 3/8")

Website: www.hkhplaster.com



HKH P417

500 x 580 x 75 (19 11/16" x 22 13/16" x 2 15/16")



Website: www.hkhplaster.com



HKH P414

600 x 600 x 90 (23 5/8" x 23 5/8" x 3 9/16")



HKH P418

400 x 400 x 50 (15 3/4" x 15 3/4" x 1 15/16")



HKH P419

715 x 715 x 80 (28 1/8" x 28 1/8" x 3 1/8")



HKH P421

1350 x 1350 x 20 (53 1/8" x 53 1/8" x 13/16")

Product designs are copyright reserved.



HKH P422

1900 x 1960 x 20 ($74\frac{13}{16}'' \times 77\frac{1}{8}'' \times \frac{13}{16}''$)



Website: www.hkhplaster.com

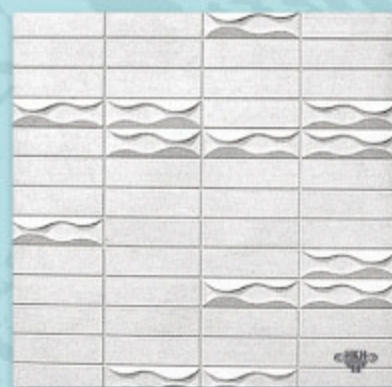

HKH P425

1080 x 850 x 12 ($42\frac{1}{2}'' \times 33\frac{7}{16}'' \times \frac{1}{2}''$)



HKH P423

845 x 1240 x 20 ($33\frac{1}{4}'' \times 48\frac{13}{16}'' \times \frac{13}{16}''$)



HKH P426

300 x 300 x 20
 $11\frac{13}{16}'' \times 11\frac{13}{16}'' \times \frac{13}{16}''$



HKH P427

400 x 400 x 20
 $15\frac{3}{4}'' \times 15\frac{3}{4}'' \times \frac{13}{16}''$



HKH P428

300 x 300 x 20
 $11\frac{13}{16}'' \times 11\frac{13}{16}'' \times \frac{13}{16}''$



HKH P424

1230 x 1050 x 35 ($48\frac{7}{16}'' \times 41\frac{5}{16}'' \times 1\frac{3}{8}''$)



HKH P429

500 x 380 x 22 ($19\frac{11}{16}'' \times 14\frac{13}{16}'' \times \frac{7}{8}''$)

Website: www.hkhplaster.com

Website: www.hkhplaster.com

Website: www.hkhplaster.com

Website: www.hkhplaster.com

Website: www.hkhplaster.com

Website: www.hkhplaster.com

Product designs are copyright reserved.

CEILING & WALL PANELS / RELIEF

UNIT = mm : Inches

Website: www.hkhplaster.com



HKH WP9
920 x 1220 x 20 (36 $\frac{1}{4}$ " x 48" x $\frac{13}{16}$ ")

PLASTER BOARD

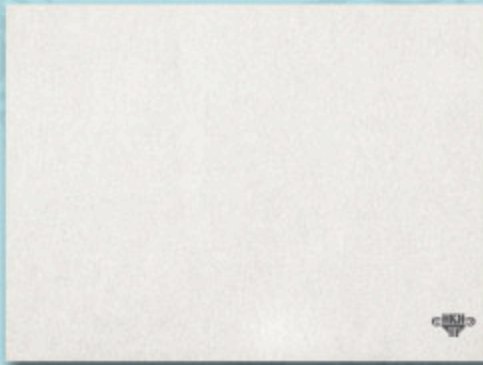

HKH PB9
1220 x 1830 x 9 (48" x 72" x $\frac{3}{8}$ ")

HKH PB12
1220 x 1830 x 12 (48" x 72" x $\frac{1}{2}$ ")

Website: www.hkhplaster.com



HKH P432
1220 x 1150 x 20 (48" x 45 $\frac{1}{2}$ " x $\frac{13}{16}$ ")

Website: www.hkhplaster.com



HKH P433
1220 x 1220 x 15 (48" x 48" x $\frac{9}{16}$ ")

Website: www.hkhplaster.com



HKH P434
1220 x 1220 x 15 (48" x 48" x $\frac{9}{16}$ ")

Website: www.hkhplaster.com

Website: www.hkhplaster.com



HKH P431
Ø 600 x 720 (23 $\frac{5}{8}$ " x 28 $\frac{5}{8}$ ")

HKH P430
Ø 770 x 980 (30 $\frac{5}{16}$ " x 38 $\frac{5}{16}$ ")

Website: www.hkhplaster.com



HKH P435
540 x 420 x 23 (21 $\frac{1}{4}$ " x 16 $\frac{5}{8}$ " x $\frac{7}{8}$ ")

Website: www.hkhplaster.com

Product designs are copyright reserved.



HKH P436

600 x 200 x 25 (23 $\frac{5}{8}$ " x 7 $\frac{7}{8}$ " x 1")



HKH P437

870 x 530 x 40 (34 $\frac{1}{2}$ " x 20 $\frac{7}{8}$ " x 1 $\frac{5}{8}$ ")



HKH P438

300 x 300 x 20
11 $\frac{13}{16}$ " x 11 $\frac{13}{16}$ " x $\frac{13}{16}$ "



HKH P439

300 x 300 x 23
11 $\frac{13}{16}$ " x 11 $\frac{13}{16}$ " x $\frac{15}{16}$ "

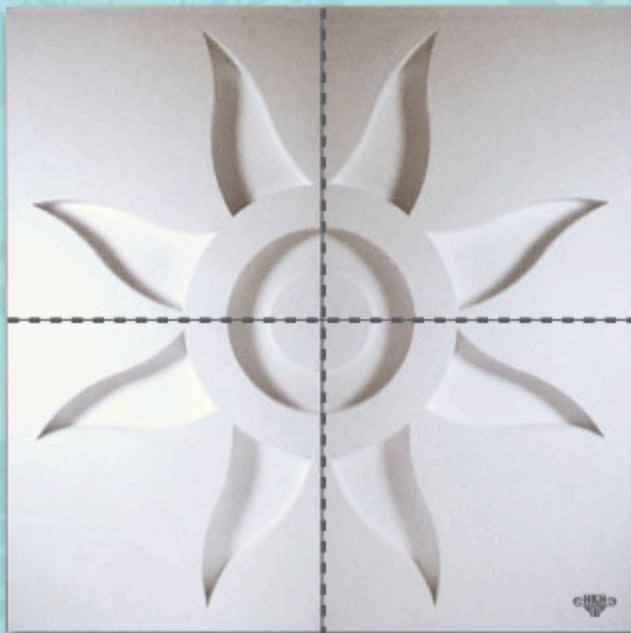

HKH P440

2032 x 2032 (80" x 80")

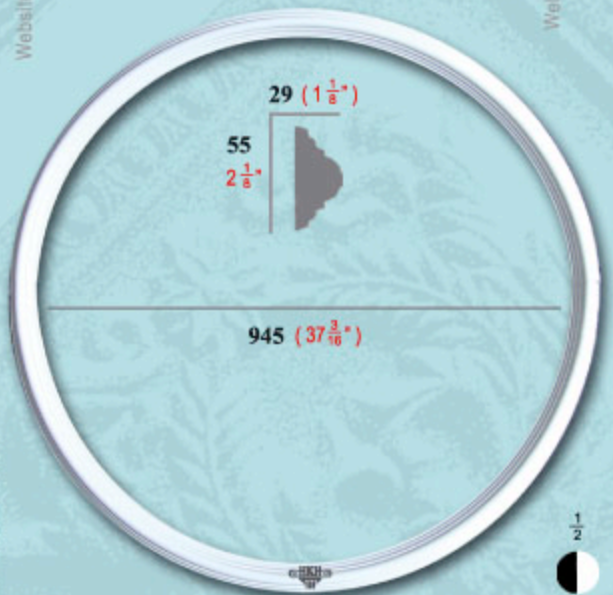

HKH P76

Ø 1000 (39 $\frac{3}{8}$ ")



Website: www.hkhplaster.com

Website: www.hkhplaster.com

Website: www.hkhplaster.com

Website: www.hkhplaster.com

Website: www.hkhplaster.com

Website: www.hkhplaster.com

Product designs are copyright reserved.

CIRCULAR Moulding

L-PANEL / ARCH & ACCESS PANEL

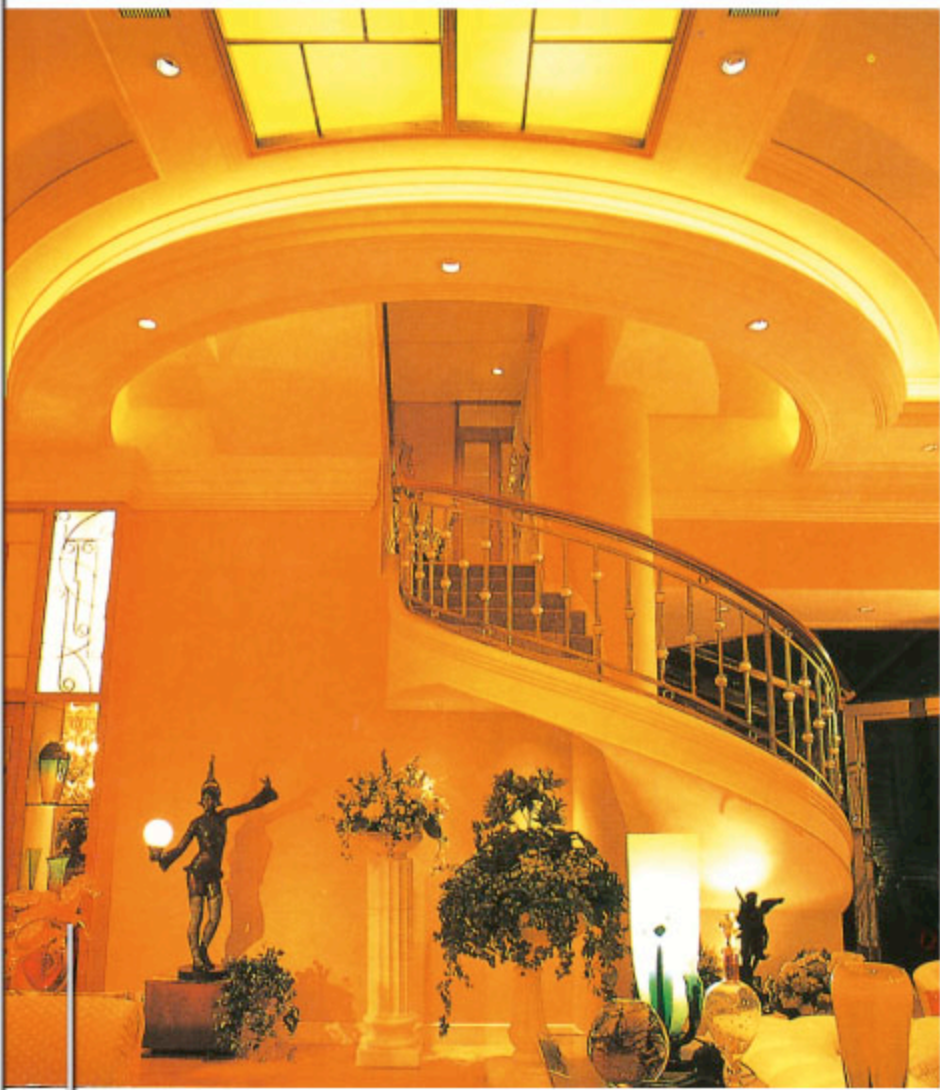

Endless design possibilities are the hallmark of these flexible mouldings. Offers tremendous labour saving when installation requires a curved or arched product.

Express your creativity with the wide range and versatility of these mouldings.

CIRCULAR MOULDING

UNIT = mm : inches

Website: www.hkhplaster.com

HKH S255 (IN)

Ø 1520 (59¹³/₁₆"*)

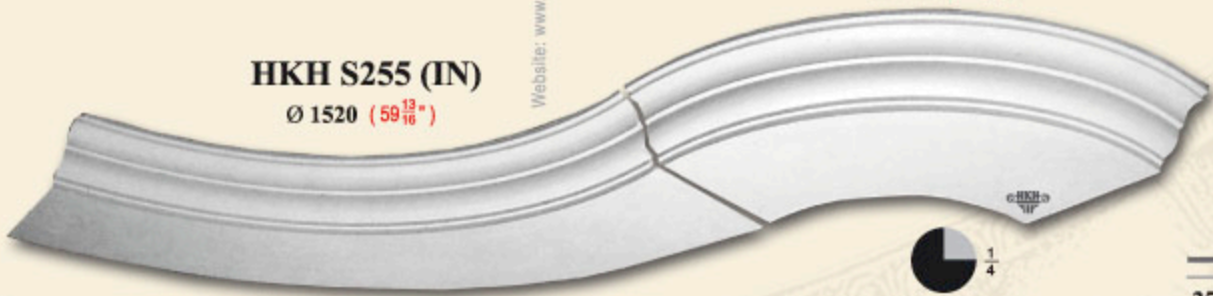

Website: www.hkhplaster.com

HKH S255 (OUT)

Ø 2020 (79¹/₂"*)



115
4¹/₂"
250 (9¹³/₁₆"*)

Website: www.hkhplaster.com

HKH S612 (IN)

Ø 1525 (60¹/₁₆"*)



Website: www.hkhplaster.com

HKH S612 (OUT)

Ø 1525 (60¹/₁₆"*)



150
5⁷/₈"
300 (11¹³/₁₆"*)

Website: www.hkhplaster.com

HKH S580A (IN)

Ø 1500 (59¹/₁₆"*)



Website: www.hkhplaster.com

HKH S580A (OUT)

Ø 1500 (59¹/₁₆"*)



143
5⁵/₈"
260 (10¹/₄"*)

Website: www.hkhplaster.com

HKH S922 (IN)

A: Ø 1500
59¹/₁₆"*

B: Ø 2400
94¹/₂"*

C: Ø 4800
189"



Website: www.hkhplaster.com

HKH S922 (OUT)

A: Ø 1500
59¹/₁₆"*

B: Ø 2400
94¹/₂"*

C: Ø 4800
189"



150
5⁷/₈"
400 (15³/₄"*)

Product designs are copyright reserved.

CIRCULAR MOULDING / L-PANEL

UNIT = mm : inches

HKH S932 (OUT)

HKH S932 (IN)

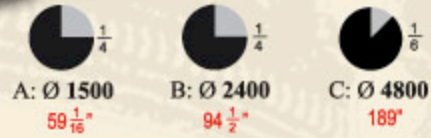
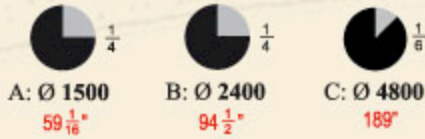

HKH S949 (OUT)

HKH S949 (IN)

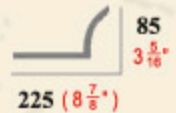

HKH S972 (OUT)

HKH S972 (IN)

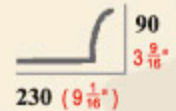
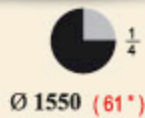

HKH S975 (OUT)

$\text{Ø } 1790 (70 \frac{1}{2}'')$

HKH S975 (IN)

$\text{Ø } 1560 (61 \frac{7}{16}'')$



$93 (3 \frac{11}{16}'')$

100
 $3 \frac{15}{16}''$

/ ARCHS / ACCESS PANEL

UNIT = mm : inches

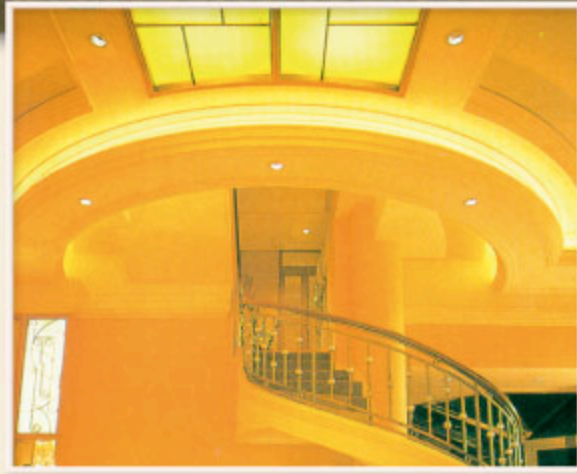

Website: www.hkhplaster.com

Website: www.hkhplaster.com

HKH S976 (IN)
Ø 1530 (60 3/4")

HKH S976 (OUT)
Ø 1530 (60 3/4")



95
3 3/4"
235 (9 1/4")

Website: www.hkhplaster.com

HKH S978 (IN)
Ø 1580 (62 3/16")

HKH S978 (OUT)
Ø 1550 (61")



110
4 15/16"
260 (10 1/4")

Website: www.hkhplaster.com

HKH S979 (IN)
Ø 1520 (59 13/16")

HKH S979 (OUT)
Ø 1500 (59 1/16")



115
4 1/2"
230 (9 1/16")

Website: www.hkhplaster.com

HKH S980 (IN)
Ø 1500 (59 1/16")

HKH S980 (OUT)
Ø 1500 (59 1/16")



95
3 3/4"
230 (9 1/16")

Website: www.hkhplaster.com

Website: www.hkhplaster.com

Product designs are copyright reserved.

CIRCULAR MOULDING / L-PANEL

UNIT = mm : inches

Website: www.hkhplaster.com

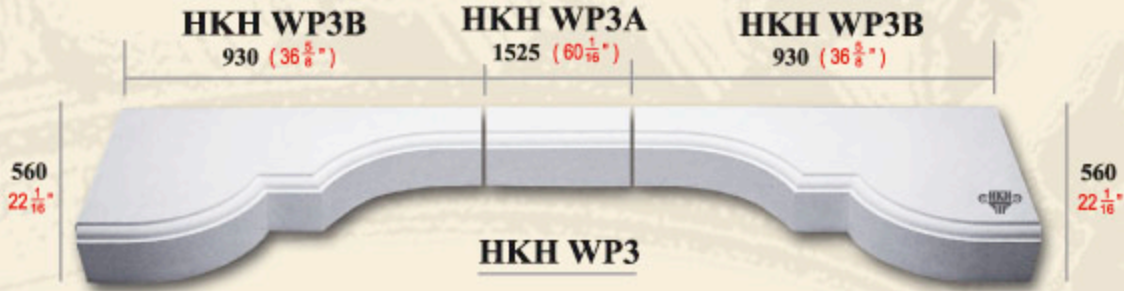

Website: www.hkhplaster.com

Website: www.hkhplaster.com



Website: www.hkhplaster.com

Website: www.hkhplaster.com

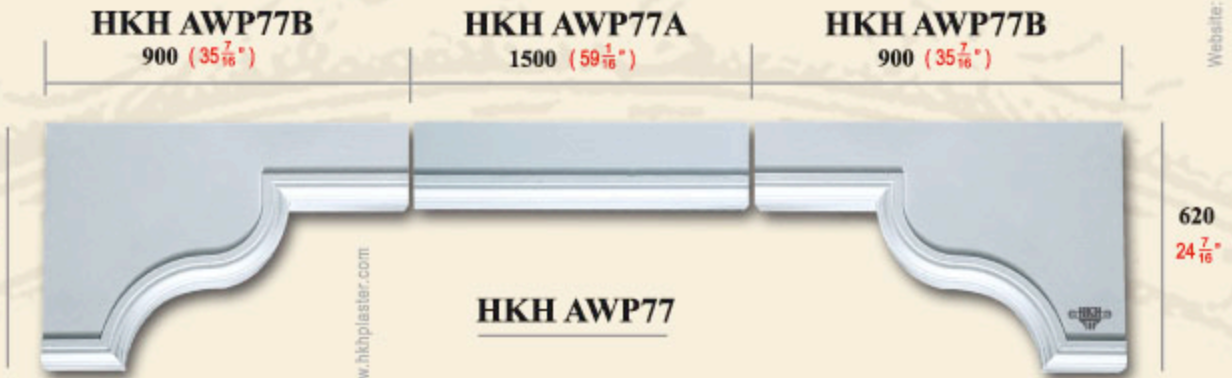

Website: www.hkhplaster.com

Product designs are copyright reserved.



Website: www.hkhplaster.com

Website: www.hkhplaster.com

HKH LB (L-BOX)

- A) 63 x 150 x 2360 ($2\frac{1}{2}'' \times 5\frac{7}{8}'' \times 92\frac{7}{8}''$)
- B) 100 x 300 x 2360 ($3\frac{15}{16}'' \times 11\frac{13}{16}'' \times 92\frac{7}{8}''$)
- C) 100 x 200 x 2360 ($3\frac{15}{16}'' \times 7\frac{7}{8}'' \times 92\frac{7}{8}''$)
- D) 175 x 225 x 2360 ($6\frac{7}{8}'' \times 8\frac{7}{8}'' \times 92\frac{7}{8}''$)
- E) 150 x 200 x 2360 ($5\frac{7}{8}'' \times 7\frac{7}{8}'' \times 92\frac{7}{8}''$)
- F) 150 x 300 x 2360 ($5\frac{7}{8}'' \times 11\frac{13}{16}'' \times 92\frac{7}{8}''$)
- G) 300 x 300 x 2360 ($11\frac{13}{16}'' \times 11\frac{13}{16}'' \times 92\frac{7}{8}''$)
- H) 150 x 450 x 2360 ($5\frac{7}{8}'' \times 17\frac{11}{16}'' \times 92\frac{7}{8}''$)

Website: www.hkhplaster.com



Website: www.hkhplaster.com

Website: www.hkhplaster.com



Smooth Surface



Smooth Surface

HKH OLB(A)

175 x 225 x 2360 ($6\frac{7}{8}'' \times 8\frac{7}{8}'' \times 92\frac{7}{8}''$)



HKH AWP66A

Length: 1500 ($59\frac{1}{8}''$)

Website: www.hkhplaster.com

Website: www.hkhplaster.com

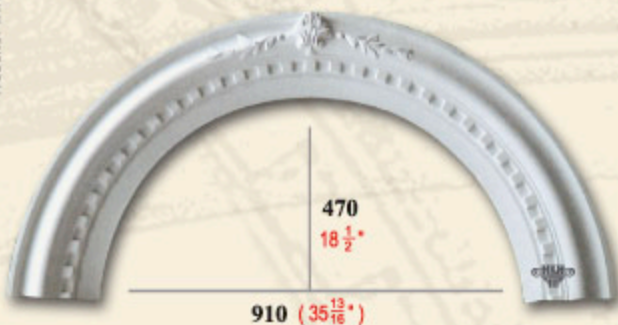

HKH AWP66B

ACCESS PANEL

ALUMINIUM FRAME

AMH - 300 x 300 (centre), 600 x 600 (side)
 $11\frac{13}{16}'' \times 11\frac{13}{16}''$ $23\frac{5}{8}'' \times 23\frac{5}{8}''$

AMH - 450 x 450 (centre), 750 x 750 (side)
 $17\frac{11}{16}'' \times 17\frac{11}{16}''$ $29\frac{1}{2}'' \times 29\frac{1}{2}''$

AMH - 600 x 600 (centre), 900 x 900 (side)
 $23\frac{5}{8}'' \times 23\frac{5}{8}''$ $35\frac{7}{16}'' \times 35\frac{7}{16}''$

Website: www.hkhplaster.com



Website: www.hkhplaster.com

NORMAL

MH - 300 x 300 (centre), 600 x 600 (side)
 $11\frac{13}{16}'' \times 11\frac{13}{16}''$ $23\frac{5}{8}'' \times 23\frac{5}{8}''$

MH - 450 x 450 (centre), 750 x 750 (side)
 $17\frac{11}{16}'' \times 17\frac{11}{16}''$ $29\frac{1}{2}'' \times 29\frac{1}{2}''$

MH - 600 x 600 (centre), 900 x 900 (side)
 $23\frac{5}{8}'' \times 23\frac{5}{8}''$ $35\frac{7}{16}'' \times 35\frac{7}{16}''$



Product designs are copyright reserved.

CIRCULAR MOULDING / L-PANEL

UNIT = mm : inches

Website: www.hkhplaster.com



Website: www.hkhplaster.com

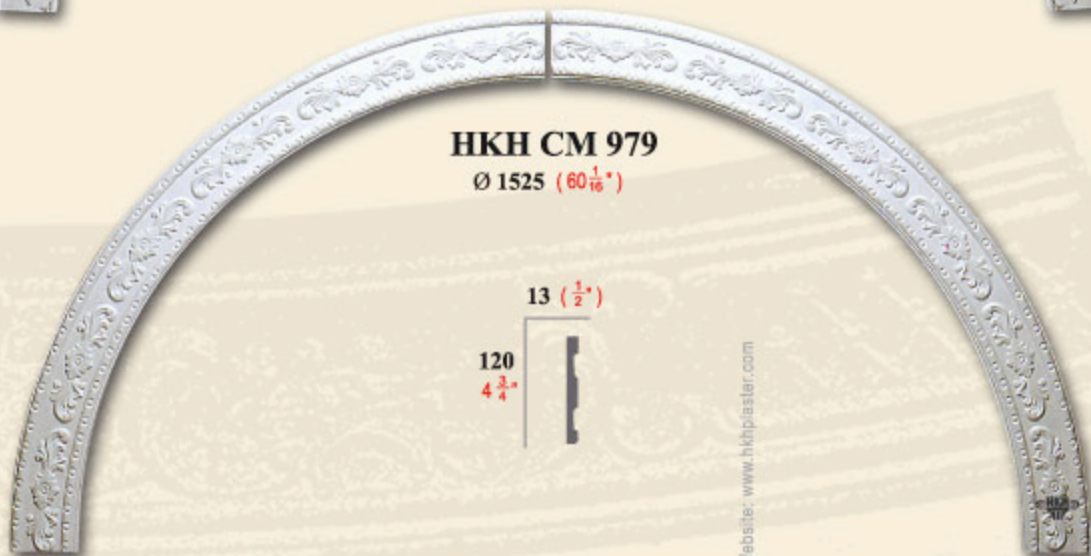
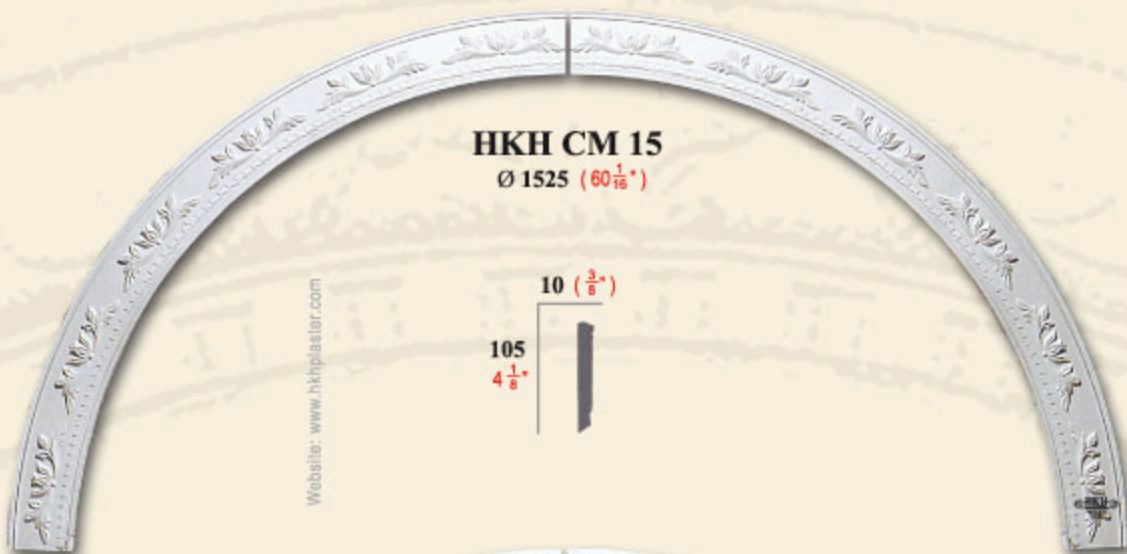

Product designs are copyright reserved.

HKH WP5

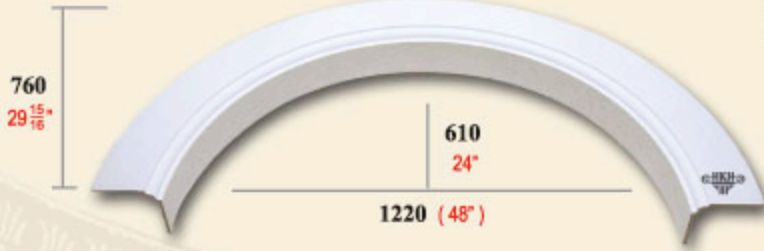

Website: www.hkhplaster.com

HKH WP6



HKH WP7



Website: www.hkhplaster.com

WP7 A  | 140 (5 1/2")
1835 (72 1/4")

WP7 B  | 220 (8 5/8")
2140 (84 1/2")

WP7 C  | 200 (7 7/8")
2440 (96 1/8")

Website: www.hkhplaster.com

Website: www.hkhplaster.com



Website: www.hkhplaster.com

Website: www.hkhplaster.com

Product designs are copyright reserved.

ROMAN ROUND & SQUARE PILLARS

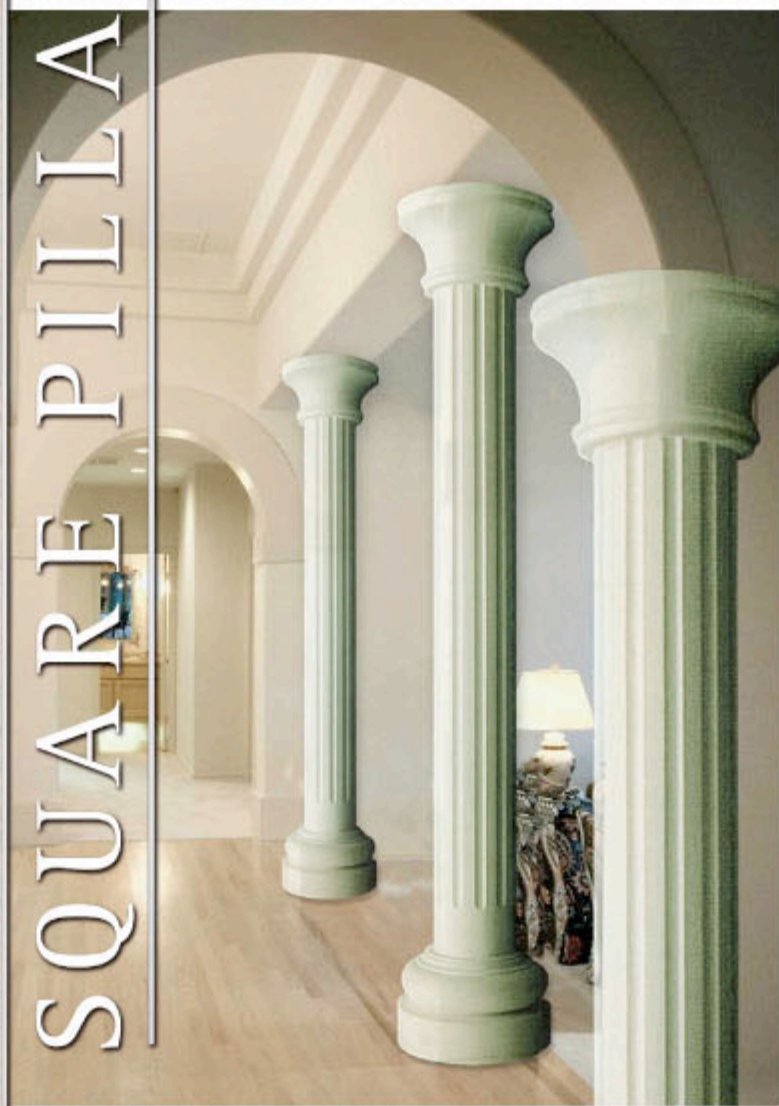

Elegant and gracefully commanding, Roman pillars are a majestic sight to behold. Easily installed, they add a strong structural form to spacious architecture, transforming plain and simple spaces to upscale sophistication of timeless beauty.

ROMAN ROUND / SQUARE PILLARS

UNIT = mm : inches

Website: www.hkhplaster.com

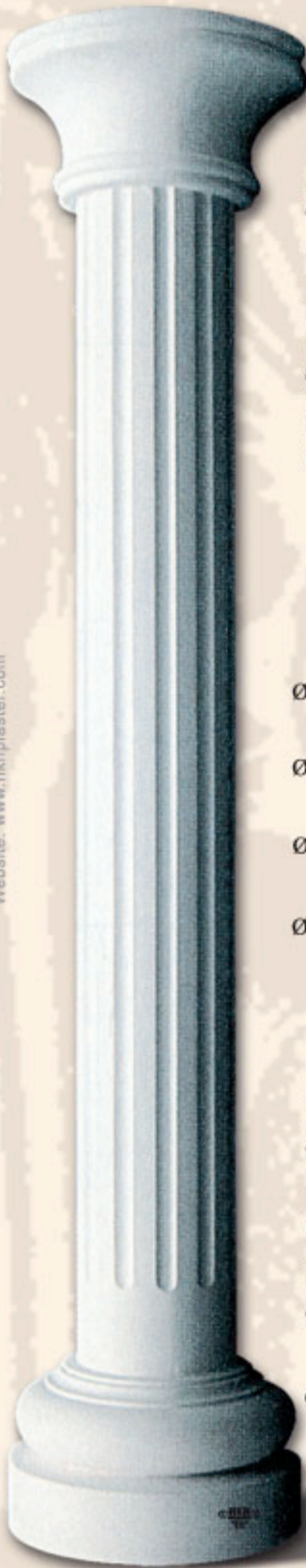

CAPITAL

HKH FC12A (A)
 $\text{Ø } 170 \times 180$ (6 $\frac{11}{16}$ " x 7 $\frac{1}{8}$ ")

HKH FC13A (A)
 $\text{Ø } 220 \times 180$ (8 $\frac{5}{8}$ " x 7 $\frac{1}{8}$ ")

HKH FC16A (A)
 $\text{Ø } 270 \times 180$ (10 $\frac{5}{8}$ " x 7 $\frac{1}{8}$ ")

HKH FC20A (A)
 $\text{Ø } 370 \times 180$ (14 $\frac{9}{16}$ " x 7 $\frac{1}{8}$ ")

PILLAR

HKH FC12
 $\text{Ø } 150 \times 2430$ (5 $\frac{7}{8}$ " x 95 $\frac{11}{16}$ ")

HKH FC13
 $\text{Ø } 200 \times 2430$ (7 $\frac{7}{8}$ " x 95 $\frac{11}{16}$ ")

HKH FC16
 $\text{Ø } 250 \times 2430$ (9 $\frac{13}{16}$ " x 95 $\frac{11}{16}$ ")

HKH FC20
 $\text{Ø } 350 \times 2430$ (13 $\frac{3}{4}$ " x 95 $\frac{11}{16}$ ")

BASE

HKH FC12B (A)
 $\text{Ø } 170 \times 180$ (6 $\frac{11}{16}$ " x 7 $\frac{1}{8}$ ")

HKH FC13B (A)
 $\text{Ø } 220 \times 180$ (8 $\frac{5}{8}$ " x 7 $\frac{1}{8}$ ")

HKH FC16B (A)
 $\text{Ø } 270 \times 180$ (10 $\frac{5}{8}$ " x 7 $\frac{1}{8}$ ")

HKH FC20B (A)
 $\text{Ø } 370 \times 180$ (14 $\frac{9}{16}$ " x 7 $\frac{1}{8}$ ")

Website: www.hkhplaster.com

HKH FC10
 $\text{Ø } 250 \times 2410$
 9 $\frac{13}{16}$ " x 94 $\frac{7}{8}$ "



465 (18 $\frac{5}{16}$ ")

HKH FC17
 $\text{Ø } 200 \times 2430$
 7 $\frac{7}{8}$ " x 95 $\frac{11}{16}$ "



HKH FC17B (A)
 $\text{Ø } 290 \times 190$
 11 $\frac{7}{16}$ " x 7 $\frac{1}{2}$ "

Website: www.hkhplaster.com

Website: www.hkhplaster.com

Website: www.hkhplaster.com

Website: www.hkhplaster.com

Product designs are copyright reserved.

ROMAN ROUND/SQUARE PILLARS

UNIT = mm / inches



HKH FC12A (C)

Ø 150 x 340 x 340 x 290
 $5\frac{7}{8}'' \times 13\frac{3}{8}'' \times 13\frac{3}{8}'' \times 11\frac{7}{16}''$

HKH FC13A (C)

Ø 200 x 340 x 340 x 290
 $7\frac{7}{8}'' \times 13\frac{3}{8}'' \times 13\frac{3}{8}'' \times 11\frac{7}{16}''$

HKH FC17A (C)

Ø 200 x 340 x 340 x 290
 $7\frac{7}{8}'' \times 13\frac{3}{8}'' \times 13\frac{3}{8}'' \times 11\frac{7}{16}''$



HKH FC13A (B)

Ø 200 x 360 x 360 x 320
 $7\frac{7}{8}'' \times 14\frac{3}{16}'' \times 14\frac{3}{16}'' \times 12\frac{5}{16}''$

HKH FC17A (B)

Ø 200 x 360 x 360 x 320
 $7\frac{7}{8}'' \times 14\frac{3}{16}'' \times 14\frac{3}{16}'' \times 12\frac{5}{16}''$

HKH FC16A (B)

Ø 250 x 410 x 410 x 320
 $9\frac{13}{16}'' \times 16\frac{1}{8}'' \times 16\frac{1}{8}'' \times 12\frac{5}{16}''$

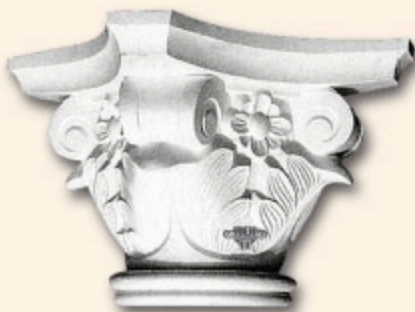

HKH FC12A (J)

Ø 150 x 330 x 330 x 250
 $5\frac{7}{8}'' \times 13'' \times 13'' \times 9\frac{13}{16}''$



HKH FC13A (H)

Ø 200 x 350 x 350 x 150
 $7\frac{7}{8}'' \times 13\frac{3}{4}'' \times 13\frac{3}{4}'' \times 5\frac{7}{8}''$

HKH FC17A (H)

Ø 200 x 350 x 350 x 150
 $7\frac{7}{8}'' \times 13\frac{3}{4}'' \times 13\frac{3}{4}'' \times 5\frac{7}{8}''$

HKH FC16A (H)

Ø 250 x 430 x 430 x 200
 $9\frac{13}{16}'' \times 16\frac{15}{16}'' \times 16\frac{15}{16}'' \times 7\frac{7}{8}''$



HKH FC13A (F)

Ø 200 x 400 x 400 x 300
 $7\frac{7}{8}'' \times 15\frac{3}{4}'' \times 15\frac{3}{4}'' \times 11\frac{3}{4}''$

HKH FC17A (F)

Ø 200 x 400 x 400 x 300
 $7\frac{7}{8}'' \times 15\frac{3}{4}'' \times 15\frac{3}{4}'' \times 11\frac{3}{4}''$



HKH FC12B (B)

Ø 170 x 170 x 330 ($6\frac{11}{16}'' \times 6\frac{11}{16}'' \times 13''$)

HKH FC13B (B)

Ø 220 x 170 x 330 ($8\frac{5}{8}'' \times 6\frac{11}{16}'' \times 13''$)

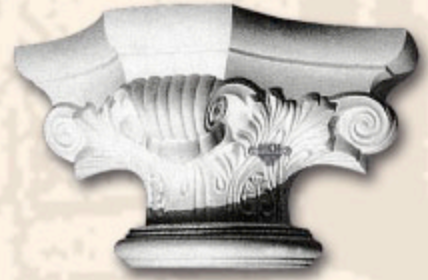

HKH FC12A (G)

Ø 150 x 400 x 400 x 250
 $5\frac{7}{8}'' \times 15\frac{3}{4}'' \times 15\frac{3}{4}'' \times 9\frac{13}{16}''$

HKH FC13A (G)

Ø 200 x 400 x 400 x 250
 $7\frac{7}{8}'' \times 15\frac{3}{4}'' \times 15\frac{3}{4}'' \times 9\frac{13}{16}''$

HKH FC17A (G)

Ø 200 x 400 x 400 x 250
 $7\frac{7}{8}'' \times 15\frac{3}{4}'' \times 15\frac{3}{4}'' \times 9\frac{13}{16}''$



HKH FC13A (E)

Ø 200 x 420 x 420 x 460
 $7\frac{7}{8}'' \times 16\frac{5}{16}'' \times 16\frac{5}{16}'' \times 18\frac{1}{8}''$

HKH FC17A (E)

Ø 200 x 420 x 420 x 460
 $7\frac{7}{8}'' \times 16\frac{5}{16}'' \times 16\frac{5}{16}'' \times 18\frac{1}{8}''$

HKH FC16A (E)

Ø 250 x 420 x 420 x 460
 $9\frac{13}{16}'' \times 16\frac{5}{16}'' \times 16\frac{5}{16}'' \times 18\frac{1}{8}''$



HKH FC12A (D)

Ø 150 x 250 x 250 x 160
 $5\frac{7}{8}'' \times 9\frac{13}{16}'' \times 9\frac{13}{16}'' \times 6\frac{5}{16}''$

Website: www.hkhplaster.com

Website: www.hkhplaster.com

Website: www.hkhplaster.com

Website: www.hkhplaster.com

Website: www.hkhplaster.com

Website: www.hkhplaster.com

Website: www.hkhplaster.com

Website: www.hkhplaster.com

Product designs are copyright reserved.

HKH FC 28A(A)
HKH FC 29A(A)
HKH FC 30A(A)

320 (12 $\frac{9}{16}$ "*)
 400 (15 $\frac{3}{4}$ "*)
 640 (25 $\frac{3}{16}$ "*)

220 (8 $\frac{5}{8}$ "*)
 280 (11"*)
 440 (17 $\frac{5}{16}$ "*)



200 (7 $\frac{7}{8}$ "*)
 250 (9 $\frac{13}{16}$ "*)
 400 (14 $\frac{3}{4}$ "*)



HKH FC28
 2450 x 200 x 12
 96 $\frac{7}{16}$ "* x 7 $\frac{7}{8}$ "* x $\frac{1}{2}$ "*

HKH FC29
 2450 x 250 x 12
 96 $\frac{7}{16}$ "* x 9 $\frac{13}{16}$ "* x $\frac{1}{2}$ "*

HKH FC30
 2450 x 400 x 12
 96 $\frac{7}{16}$ "* x 14 $\frac{3}{4}$ "* x $\frac{1}{2}$ "*

HKH FC 28B(A)
HKH FC 29B(A)
HKH FC 30B(A)

200 (7 $\frac{7}{8}$ "*)
 250 (9 $\frac{13}{16}$ "*)
 400 (14 $\frac{3}{4}$ "*)

120 (4 $\frac{3}{4}$ "*)
 150 (5 $\frac{7}{8}$ "*)
 200 (7 $\frac{7}{8}$ "*)

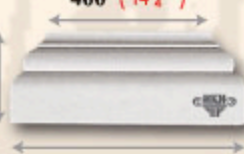

320 (12 $\frac{9}{16}$ "*)
 400 (14 $\frac{3}{4}$ "*)
 540 (21 $\frac{1}{4}$ "*)

HKH WP8

470
 18 $\frac{1}{2}$ "*

370
 14 $\frac{5}{16}$ "*

470
 18 $\frac{1}{2}$ "*



HKH FC15

Ø 470 x 2440 (18 $\frac{1}{2}$ "* x 96 $\frac{1}{16}$ "*)



HKH FC11

Ø 250 x 2440 (9 $\frac{13}{16}$ "* x 96 $\frac{1}{16}$ "*)



$\frac{1}{4}$ PC



Website: www.hkhplaster.com

Website: www.hkhplaster.com

Website: www.hkhplaster.com

Website: www.hkhplaster.com

Website: www.hkhplaster.com

Website: www.hkhplaster.com

Website: www.hkhplaster.com

Website: www.hkhplaster.com

Product designs are copyright reserved.

COATING OF PILLARS COLUMNS

UNIT = mm : inches

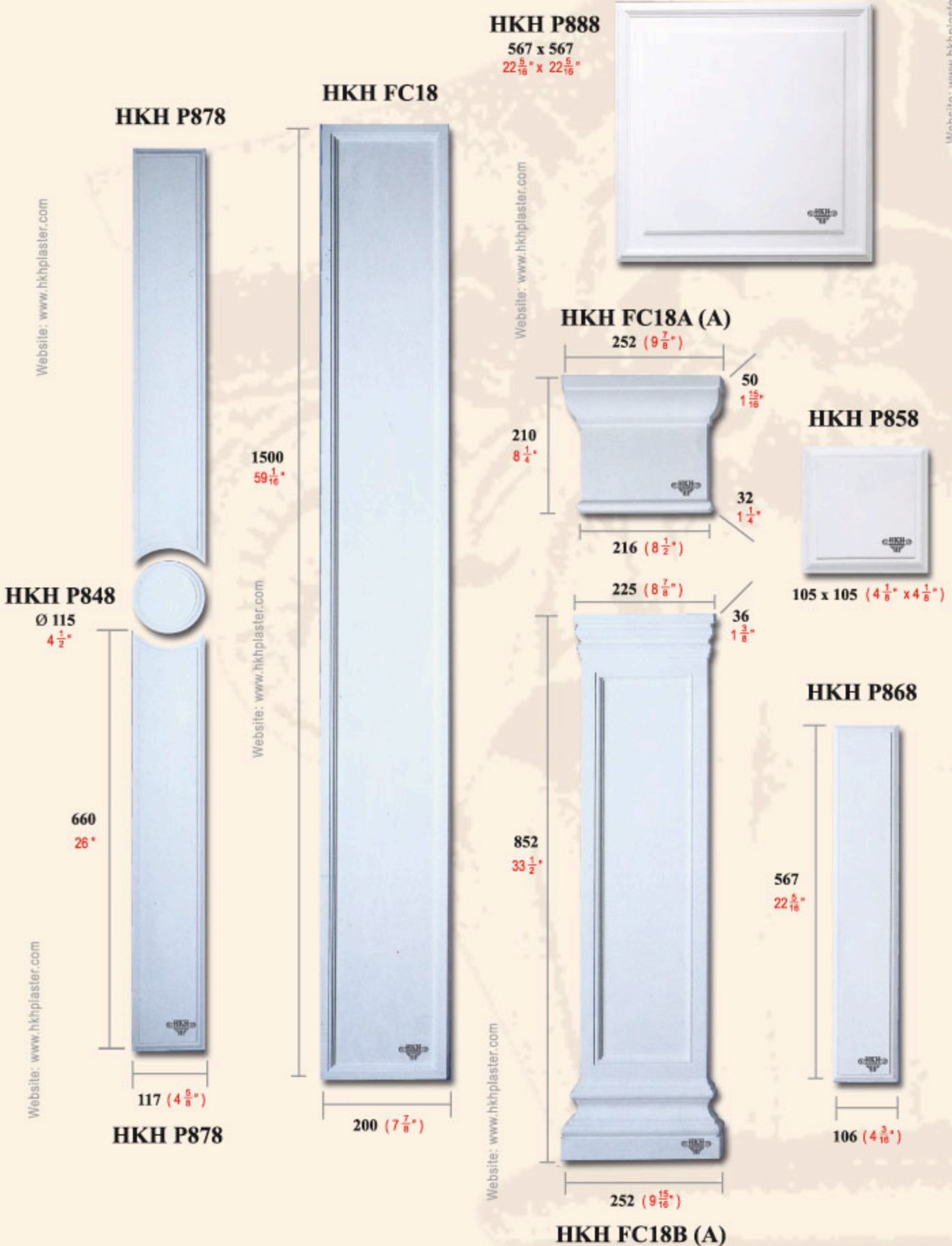

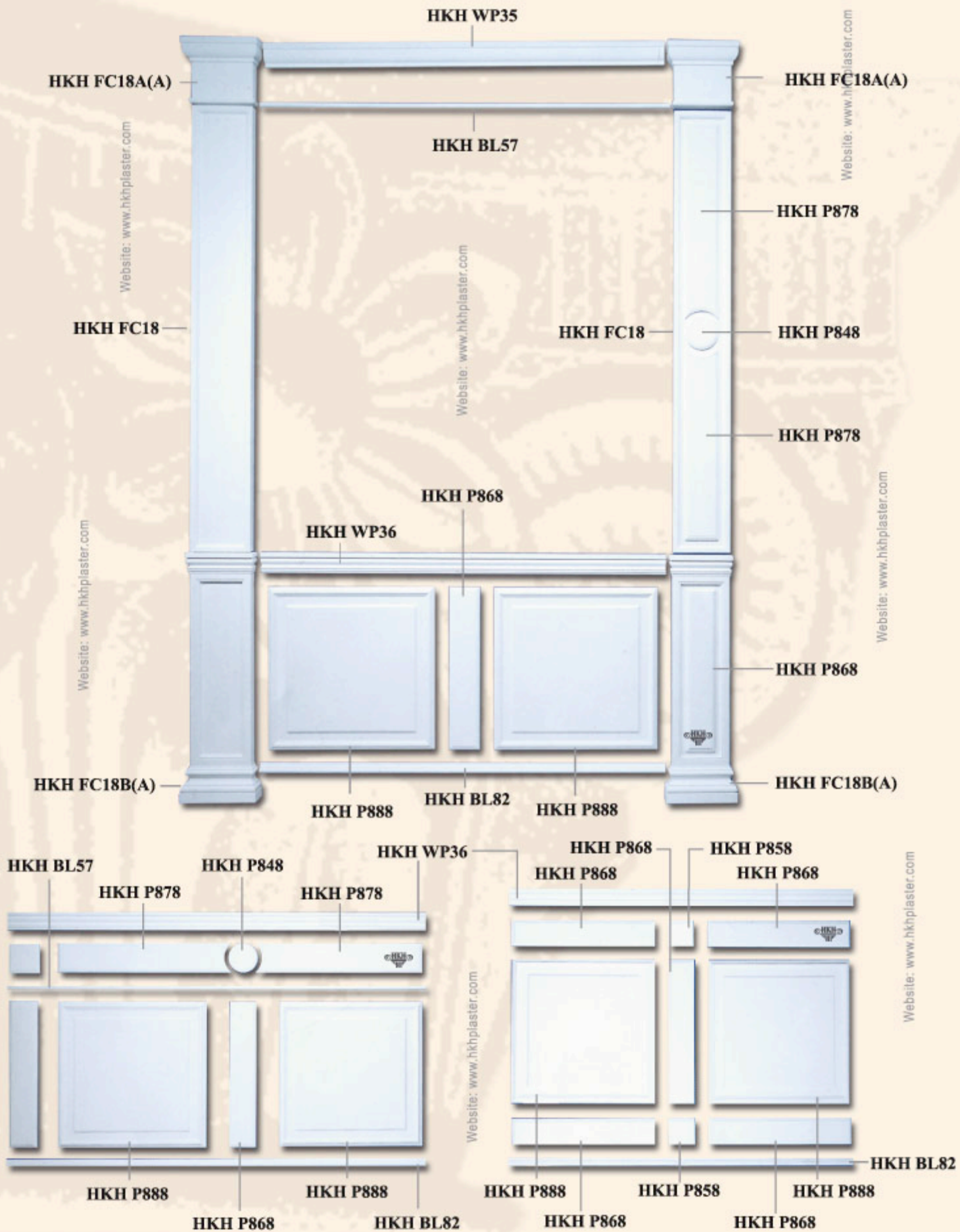

DOMES



Grand foyers, lobbies and luxurious living and dining rooms are majestically enhanced with the addition of ceiling domes. Our single-piece domes are easily utilized with elegant lighting fixtures and chandeliers or as an independent decorative element.



DOME

UNIT = mm : inches

Website: www.hkhplaster.com



Website: www.hkhplaster.com



Website: www.hkhplaster.com

280
11"
1450 (57 1/8")

HKH DM1

120
4 3/4"
700 (27 5/8")

HKH DM4

Website: www.hkhplaster.com



Website: www.hkhplaster.com



Website: www.hkhplaster.com

230
9 1/8"
1220 (48")

HKH DM2

150
5 7/8"
900 (35 7/8")

HKH DM5

Website: www.hkhplaster.com



Website: www.hkhplaster.com



Website: www.hkhplaster.com

250
9 13/16"
1070 (42 1/8")

HKH DM3

200
7 7/8"
1370 (53 15/16")

HKH DM6

Product designs are copyright reserved.

DOME

UNIT = mm : inches



HKH DM7
HKH DM28 (1/4 pc)



Website: www.hkhplaster.com

Website: www.hkhplaster.com

Website: www.hkhplaster.com



HKH DM8



HKH DM12



Website: www.hkhplaster.com

Website: www.hkhplaster.com



HKH DM9



Website: www.hkhplaster.com

Website: www.hkhplaster.com



HKH DM13



Product designs are copyright reserved.

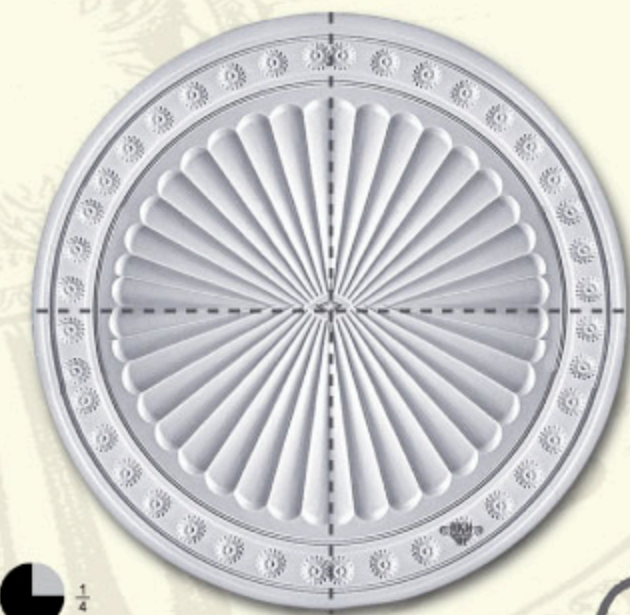

Website: www.hkhplaster.com



HKH DM14



Website: www.hkhplaster.com



Website: www.hkhplaster.com

HKH DM15
1220 x 1850 (48" x 72 13/16")
Depth: 235 (9 1/4")



HKH DM17
Ø 890 x 170 D (35 1/8" x 6 11/16")

Website: www.hkhplaster.com

Website: www.hkhplaster.com

Website: www.hkhplaster.com



HKH DM16
Ø 830 (32 3/8")
Depth: 100 (3 15/16")

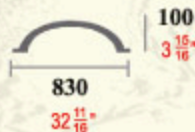

HKH DM18
1130 x 900 x 99
44 1/2" x 35 7/16" x 3 7/8"

Product designs are copyright reserved.

DO ME

UNIT = mm / inches



HKH DM19

Ø 1000 x 135 D (39 $\frac{3}{8}$ " x 5 $\frac{5}{16}$ ")



HKH DM22

125
4 $\frac{15}{16}$ "
1235
48 $\frac{5}{8}$ "



HKH DM20

Ø 900 x 180 D (35 $\frac{7}{16}$ " x 7 $\frac{1}{16}$ ")



HKH DM23

155
6 $\frac{1}{8}$ "
870
34 $\frac{1}{4}$ "



HKH DM21

155
6 $\frac{1}{8}$ "
875
34 $\frac{7}{16}$ "



HKH DM24

1220 x 890 (48" x 35 $\frac{1}{16}$ ")
Depth: 200 (7 $\frac{7}{8}$ ")

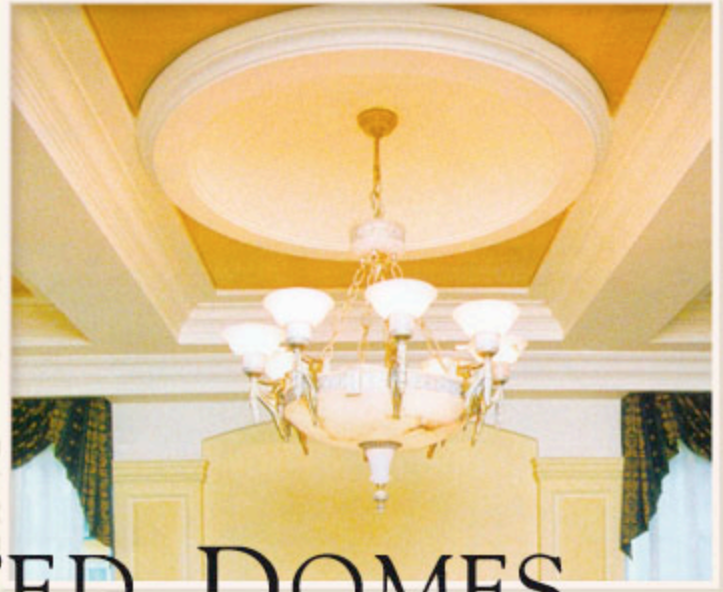

MOUNTED DOMES

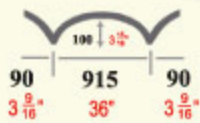

HKH DM25



HKH DM27

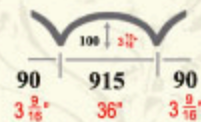

HKH DM26

Website: www.hkhplaster.com

Website: www.hkhplaster.com

Website: www.hkhplaster.com

Website: www.hkhplaster.com

Website: www.hkhplaster.com

Website: www.hkhplaster.com

Product designs are copyright reserved.



CLASSICAL & ELEGANTS

Specialise in Fibrous Plaster Mouldings,
Manufacturing and Material Supply.



HOCK KENG HENG PLASTER INDUSTRIAL SDN. BHD.

LOT 5156, MUKIM JERAM BATU, 81500 PEKAN NENAS, JOHOR, MALAYSIA.

TEL: +607-699 5000 ; +607-699 2066 ; +607-699 5149 ; +6019-714 5997.

FAX: +607-699 1788

website: www.hkhplaster.com

email: plaster@hkhplaster.com

EXCLUSIVE DEALER: